

---

**Facoltà di Scienze Matematiche, Fisiche e Naturali**  
**Dipartimento di Scienze dell'Informazione**  
**Corso di Laurea Specialistica in Scienze di Internet (Sdi) e Informatica (Inf)**

# **Sistemi e Reti Wireless**

---



**Luciano Bononi**

(bononi@cs.unibo.it)

<http://www.cs.unibo.it/~bononi/>

Ricevimento: sempre aperto .

Si consiglia di concordare via e-mail almeno un giorno prima  
(informazioni in tempo reale sulla home page personale)

Figure-credits: some figures have been taken from slides published on the Web, by the following authors (in alphabetical order):

J.J. Garcia Luna Aceves (ucsc), James F. Kurose & Keith W. Ross, Jochen Schiller (fub), Nitin Vaidya (uiuc)



# *Background on wireless PHY layer*

# RF Properties

- **Understanding Radio Frequency**
  - Generation, coverage and propagation issues
  - Fundamental for wireless planning and management
- **Radio Frequency Signals**
  - Electromagnetic energy generated by high frequency alternate current (AC) in antennas
  - Antenna: converts the wired current to RF and viceversa

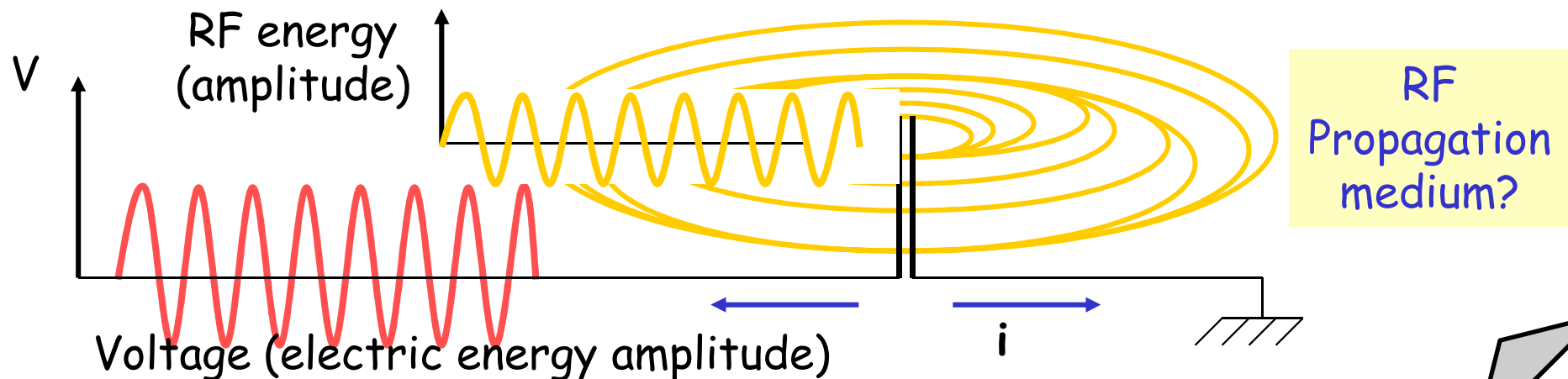

# RF Properties

- **Amplitude**
  - Higher amplitude RF signals go farther
  - Transmission Power (Watts) = Energy / Time = Joule / Sec
    - More energy (voltage) moves more electrons (current)
    - Power = Voltage \* Current

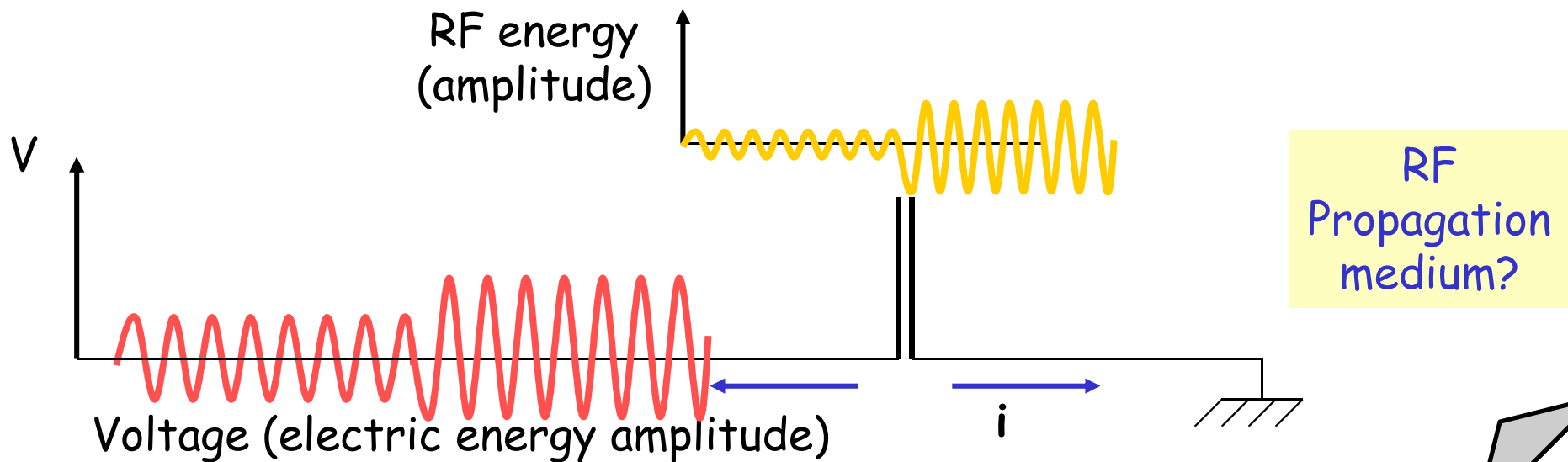

# RF Properties

- **Frequency (and Wavelength)**
  - Wireless Spectrum (see next slides)
  - Portion of wireless spectrum regulated by regional authorities and assigned to wireless technologies

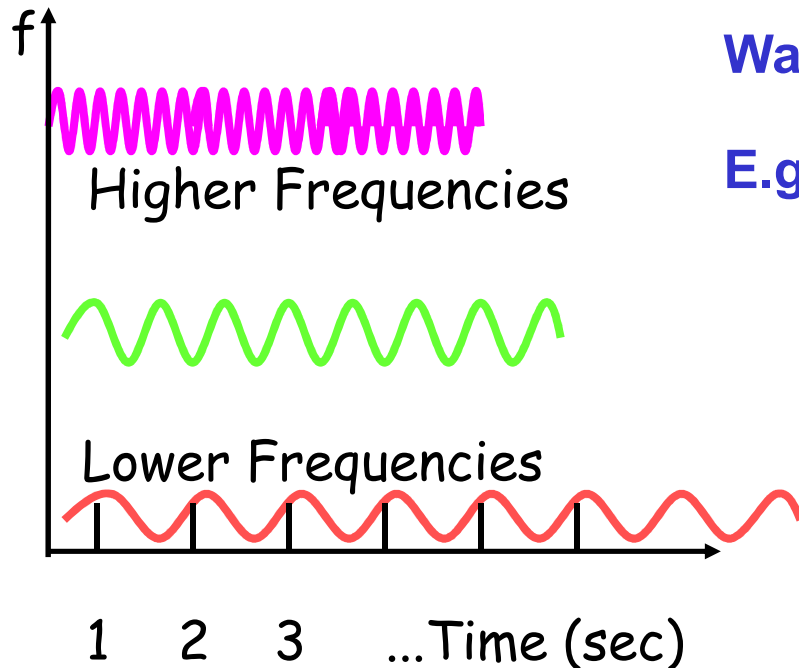

$$\text{Wavelength} = c / \text{frequency}$$

E.g. 2.4 GHz (ISM band)

Wave Length =

$$300.000.000(\text{m/s}) / 2.400.000.000 \text{ Hz} = 0.125 \text{ m} = 12.5 \text{ cm}$$

In practice:

Antennas work better with size =  $1, \frac{1}{2}, \frac{1}{4}$  of wavelegth (try to measure antenna size of your IEEE 802.11 device)

# RF propagation

- Radio transmission coverage

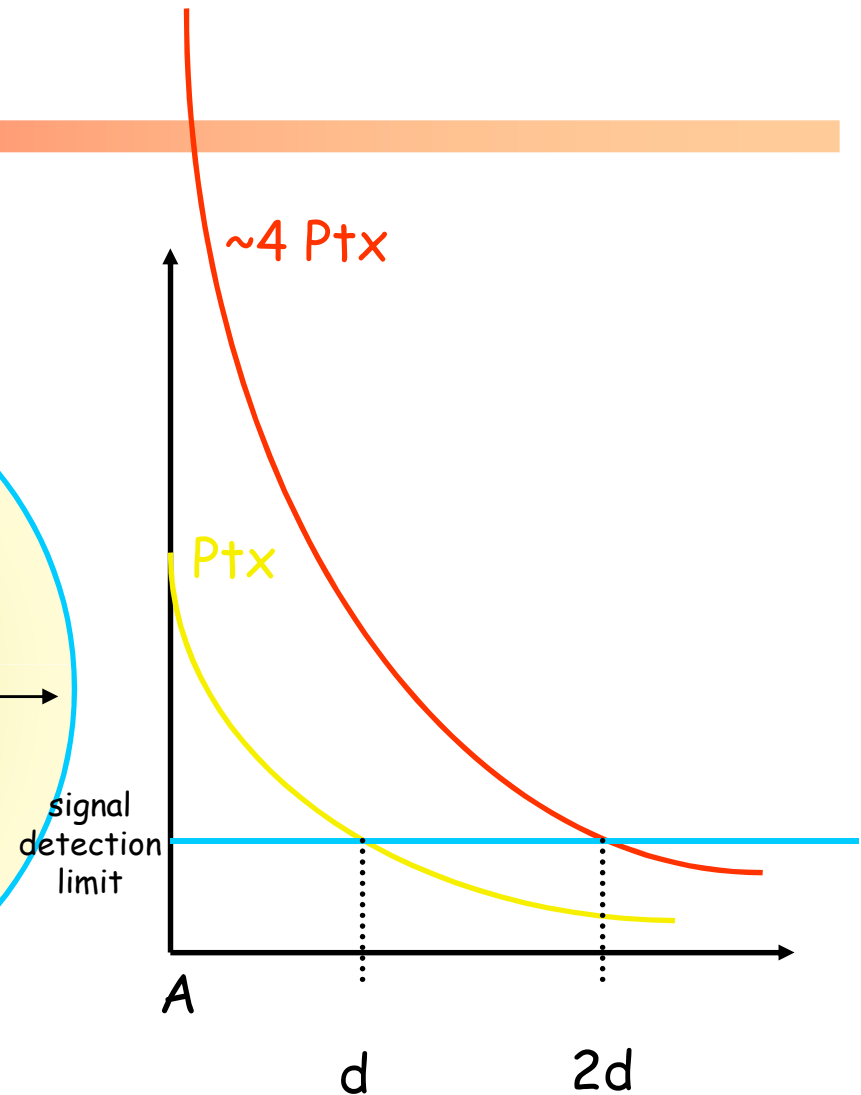
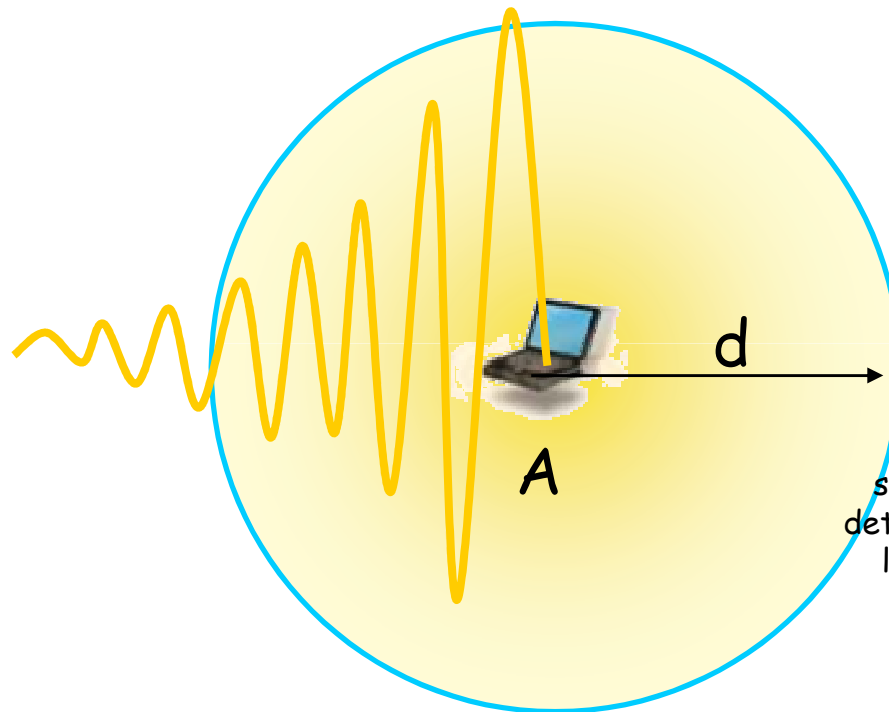

The range is a function of power transmission ( $P_{tx}$ )  
Signal strength reduces with  $d^k$   $\implies$   
( $k \geq 2..3$ , no obstacles, isotropic radiator)

In 3D, sphere:  
 $V = (4 \pi r^3 / 3)$   
 $S = (4 \pi r^2)$

# Wireless networks' technology

---

- Radio transmission coverage

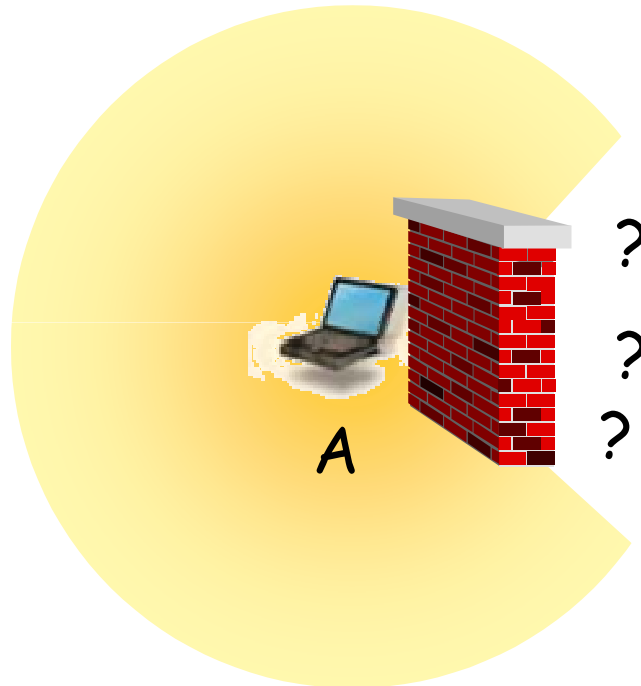

Rules of thumb:

- high frequencies are good for short distances and are affected by obstacles
- low frequencies are good for long distances and are less affected by obstacles

obstacles can reflect or absorb waves depending on materials and wave frequencies

# RF Properties

- Phase: shift of the wave (in degrees or radians)

- Positive phase (left-shift), early wavefront
- Negative phase (right-shift), late wavefront

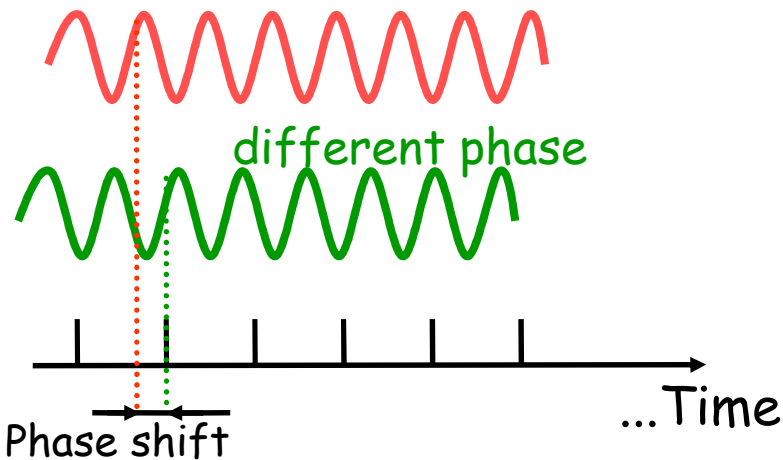

Example of signal composition with phase variations

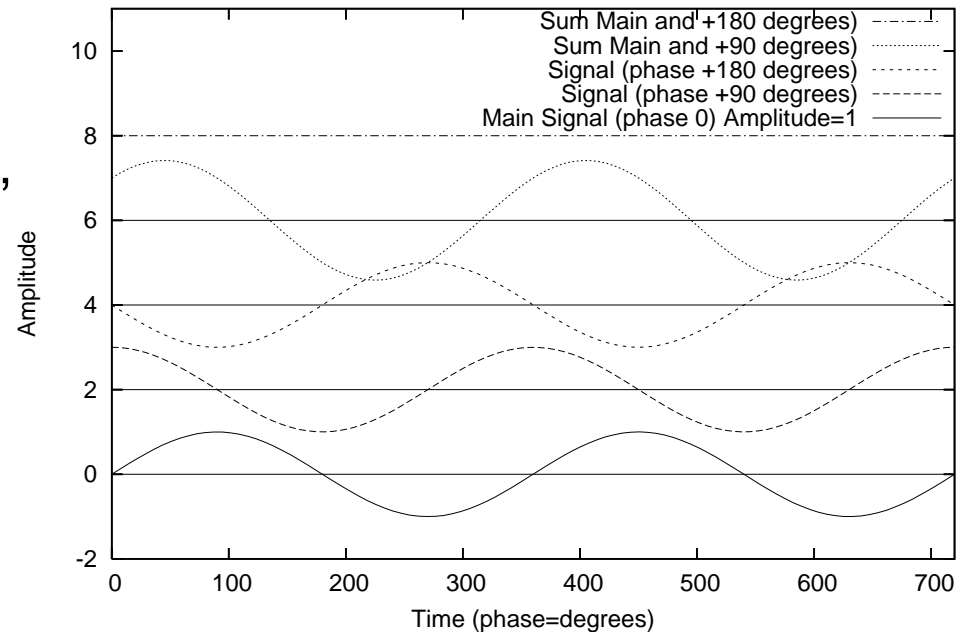

**In practice:**

RF echoes arriving at receivers with different phase may have positive or negative effects... Why?



# RF Properties

## Phase: shift of the wave (in degrees or radians)

- Positive phase (left-shift), early wavefront
- Negative phase (right-shift), late wavefront

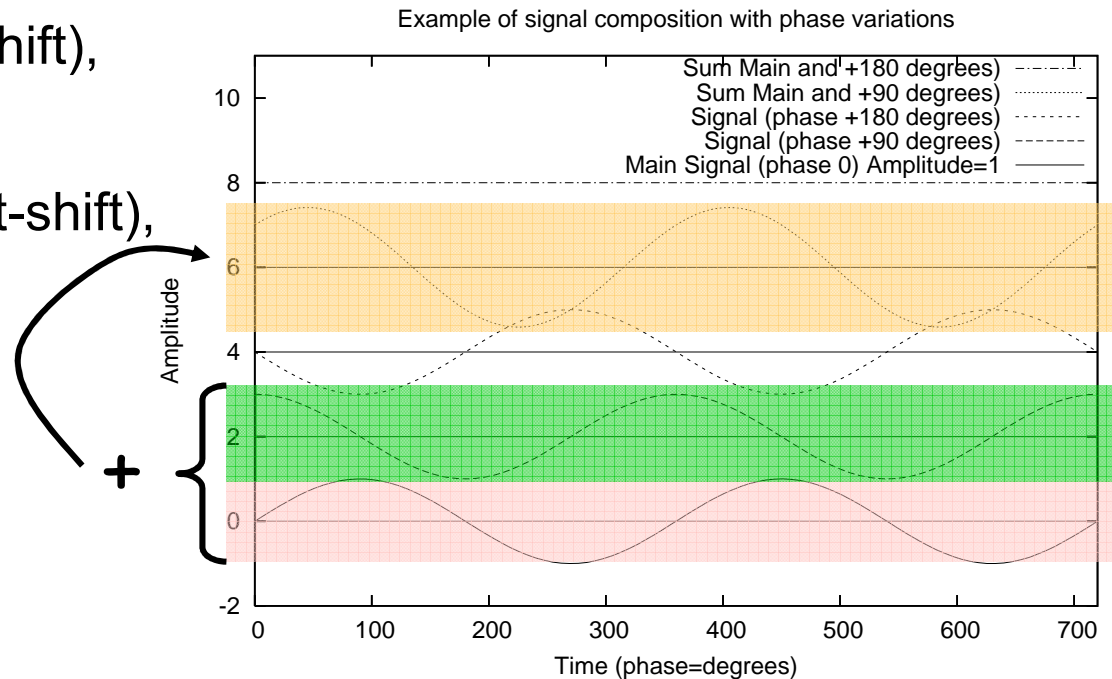
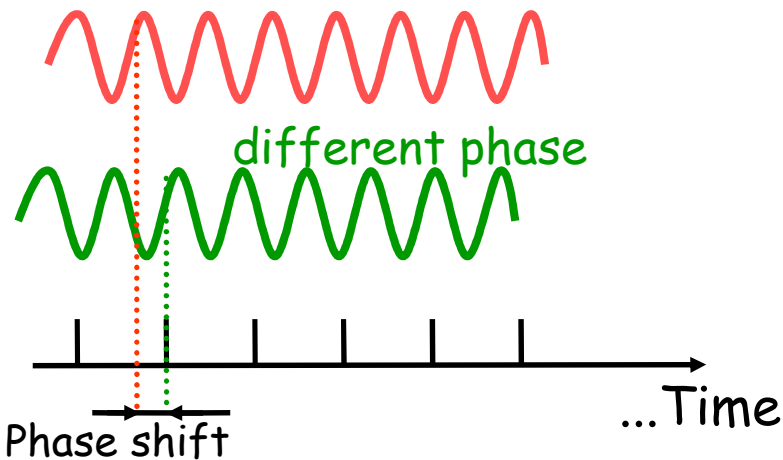

**In practice:**  
RF echoes arriving at receivers with different phase may have positive or negative effects... Why?

# RF Properties

## Phase: shift of the wave (in degrees or radians)

- Positive phase (left-shift), early wavefront
- Negative phase (right-shift), late wavefront

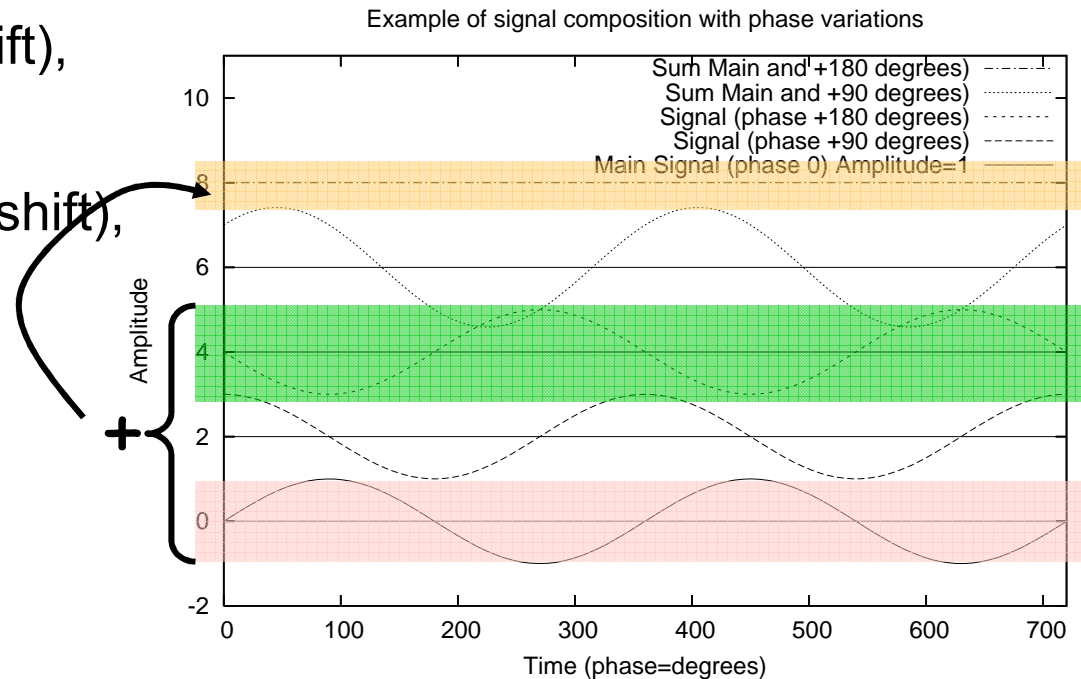
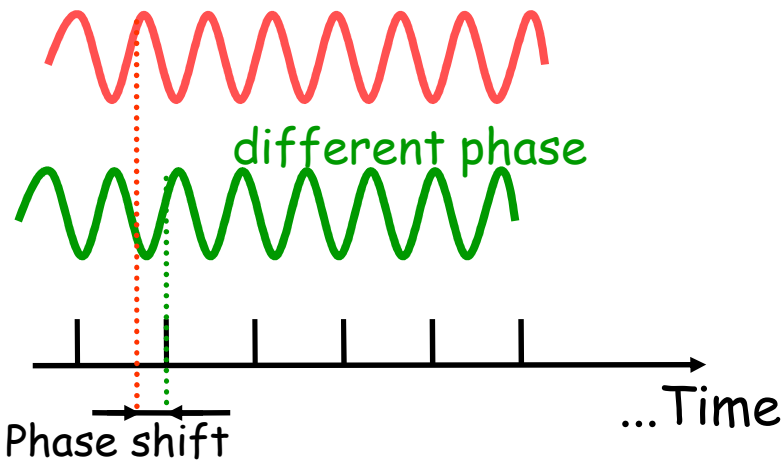

**In practice:**  
RF echoes arriving at receivers with different phase may have positive or negative effects... Why?

# RF Properties

- **Polarization: (physical orientation of antenna)**
  - RF waves are made by two perpendicular fields:
    - Electric field and Magnetic field

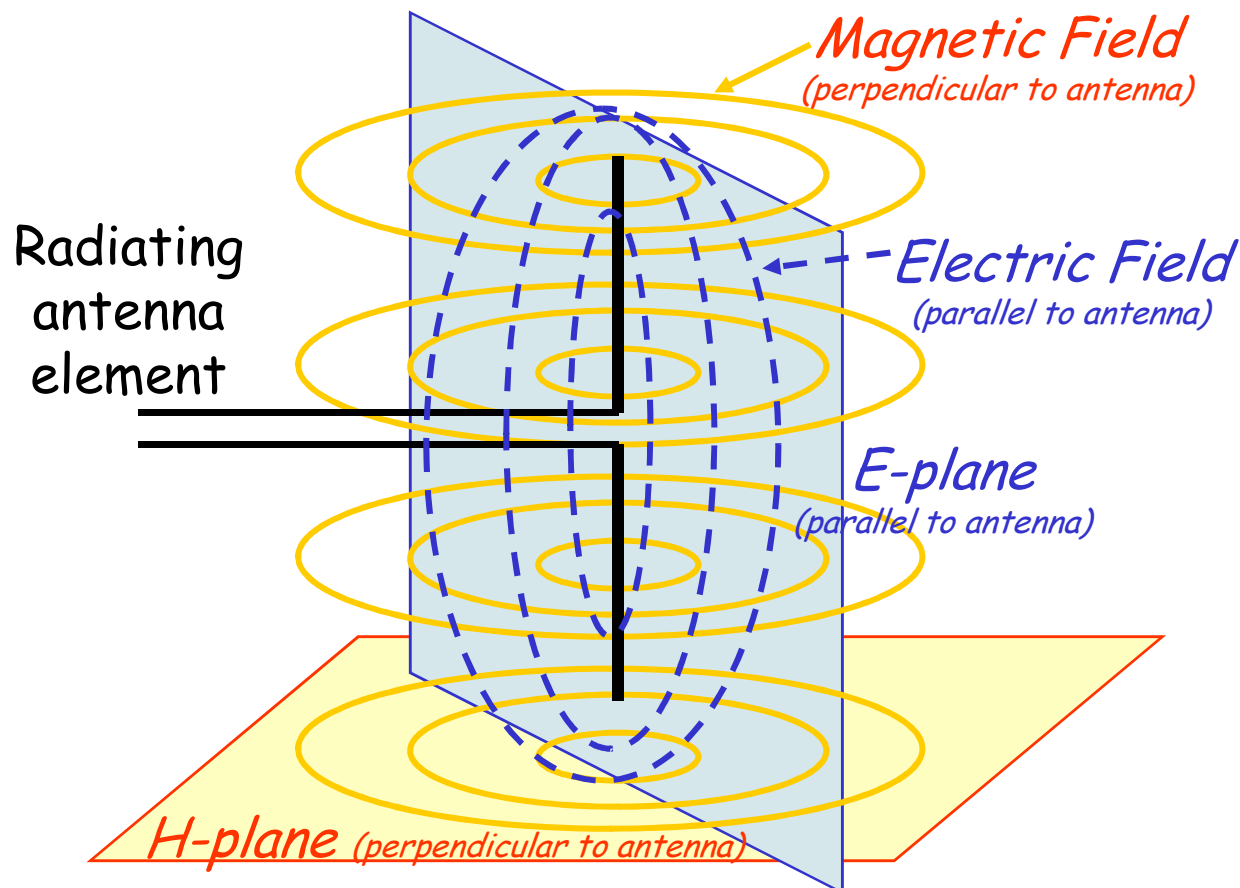

Horizontal Polarization  
(electric field is parallel to ground)

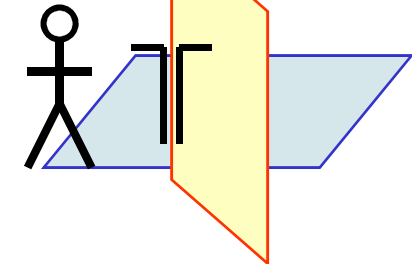

Vertical Polarization  
(electric field is perpendicular to ground)

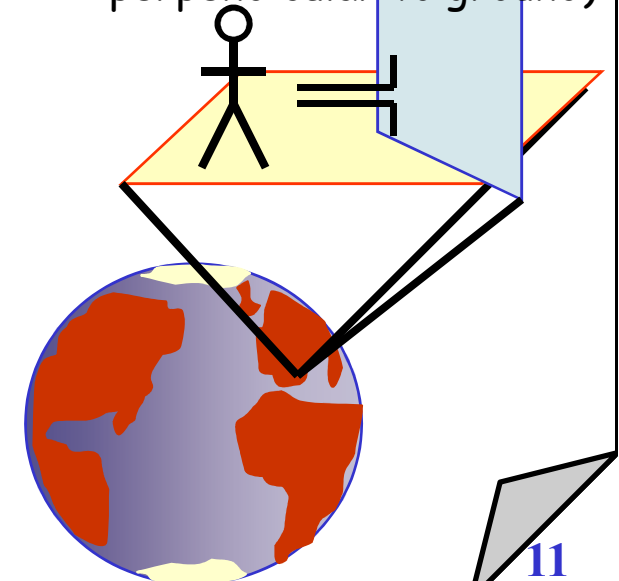

# RF Properties

## Vertical Polarization: typically used in WLANs

OK Transferred radiation OK

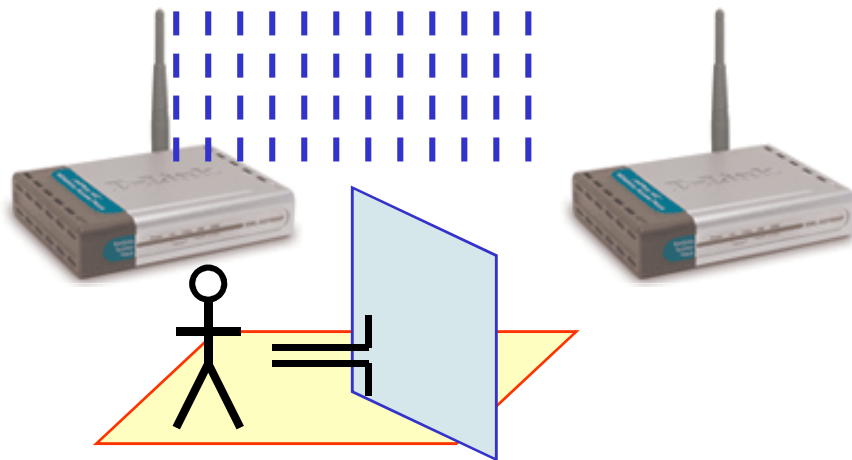

OK Transferred radiation NO

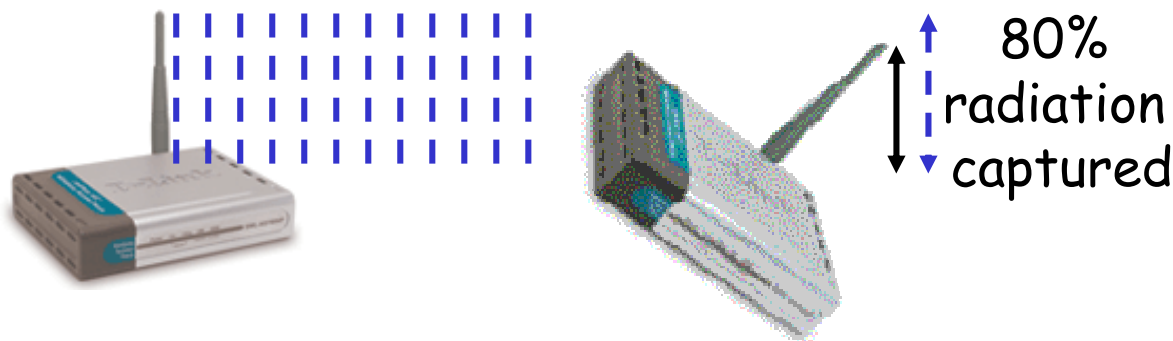

Intuitively....

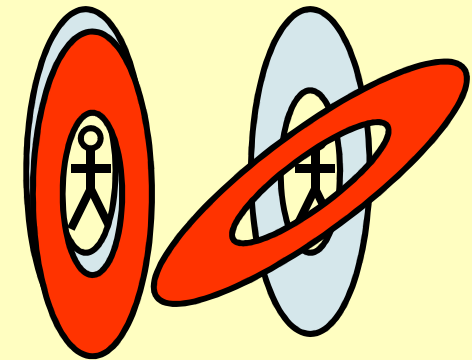

Vertical Polarization  
(electric field is perpendicular to ground)

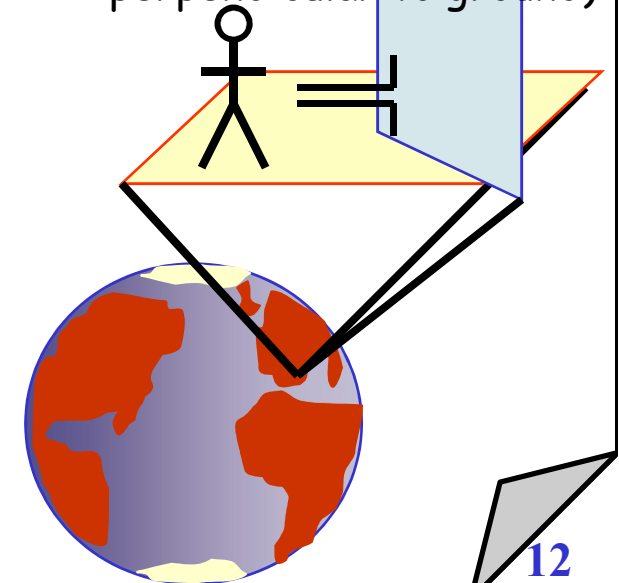

# RF Properties

## Vertical Polarization: the PCMCIA device problem

OK Transferred radiation OK

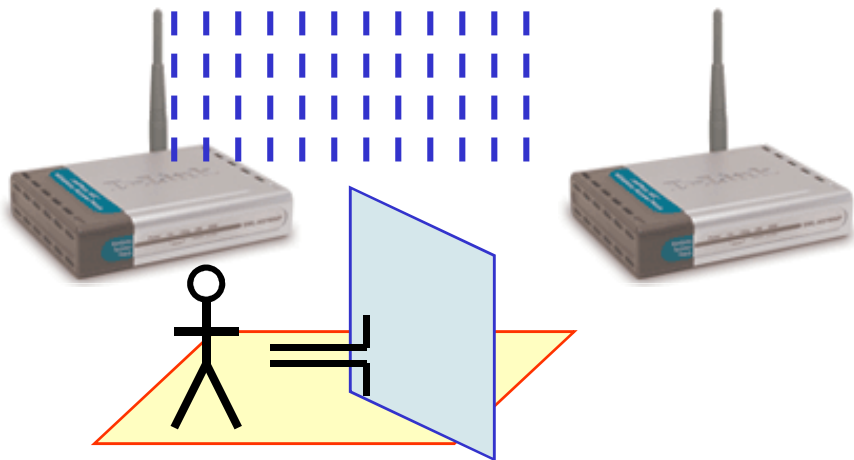

100%  
radiation  
captured

OK Transferred radiation NO

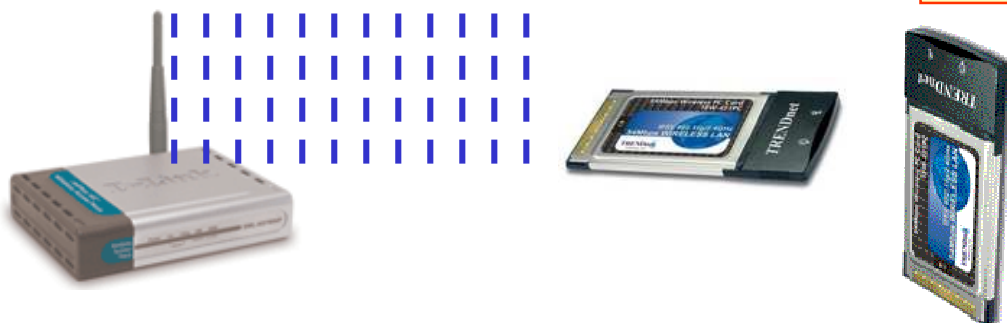

??%  
radiation  
captured

Intuitively....

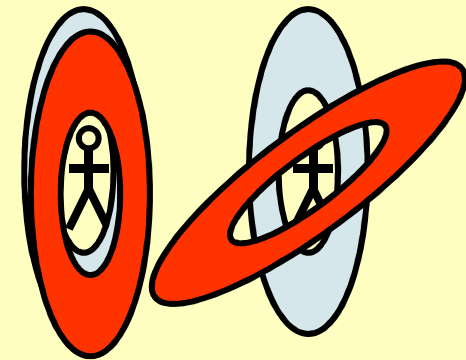

N.B. the polarization problem is very much important when using distant devices and directional antennas. With short distances signal reflections help!

# RF Behaviors

---

- Radio transmission interference

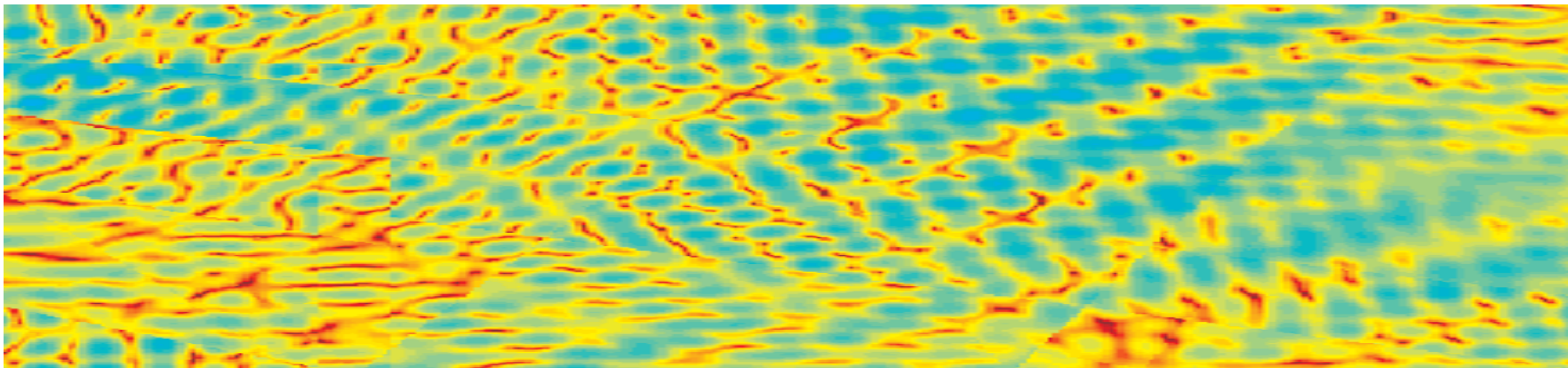
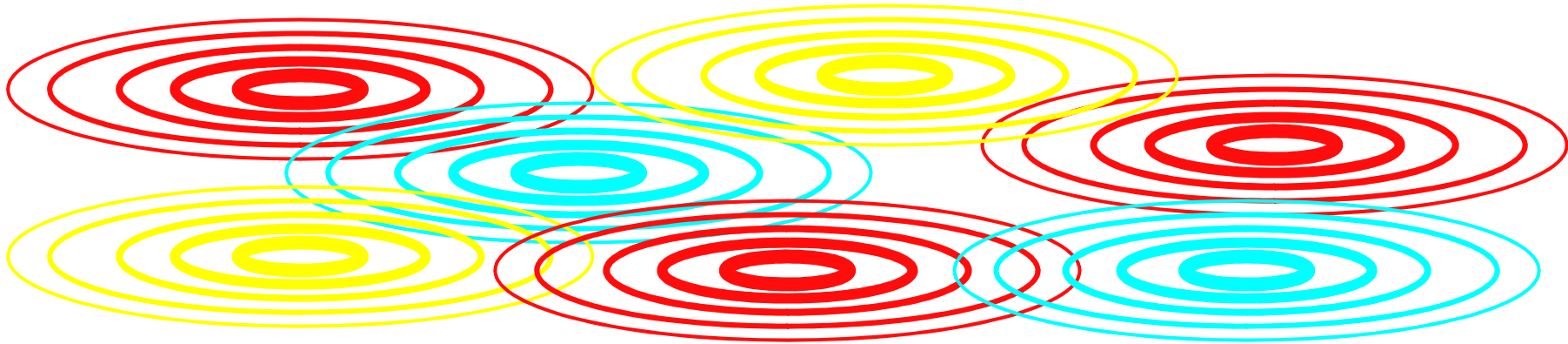

# Wireless transmission: Electromagnetic waves

- **Different parameters of electromagnetic waves:**
  - amplitude  $M$  proportional to transmission energy (loudness)
  - frequency  $f$  (tone) measured in Hertz (Cycle/sec)
  - phase  $\varphi$  (peak shift with respect to reference signal) (rad)

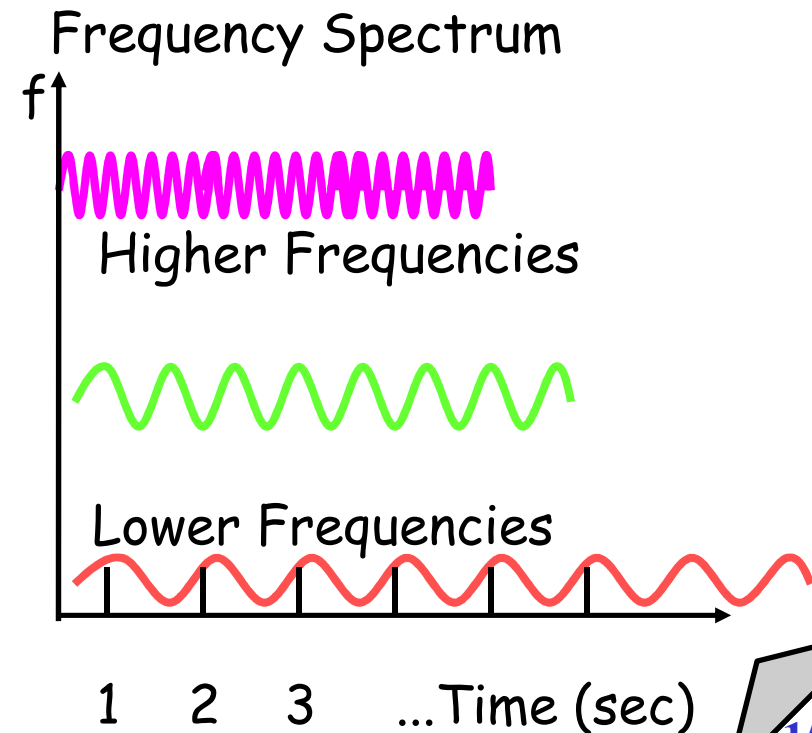
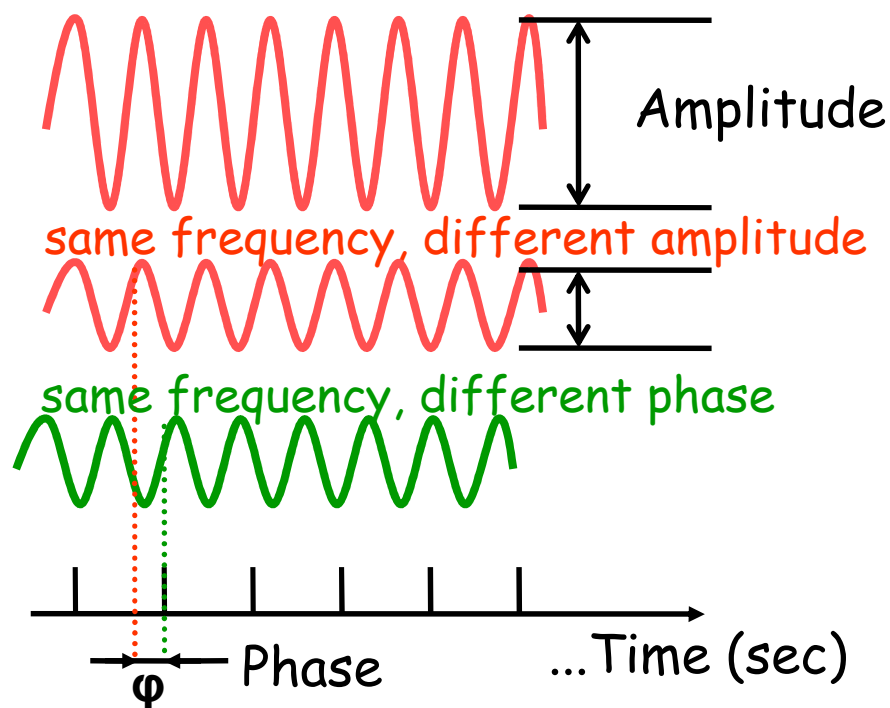

# Wireless transmission

- **Signal Gain: (measured in Decibels, Db)**
  - Increase in amplitude **M** proportional to transmission energy
    - Active gain (amplifiers)
    - Passive gain (antennas focusing signal energy, and additive signal effects)

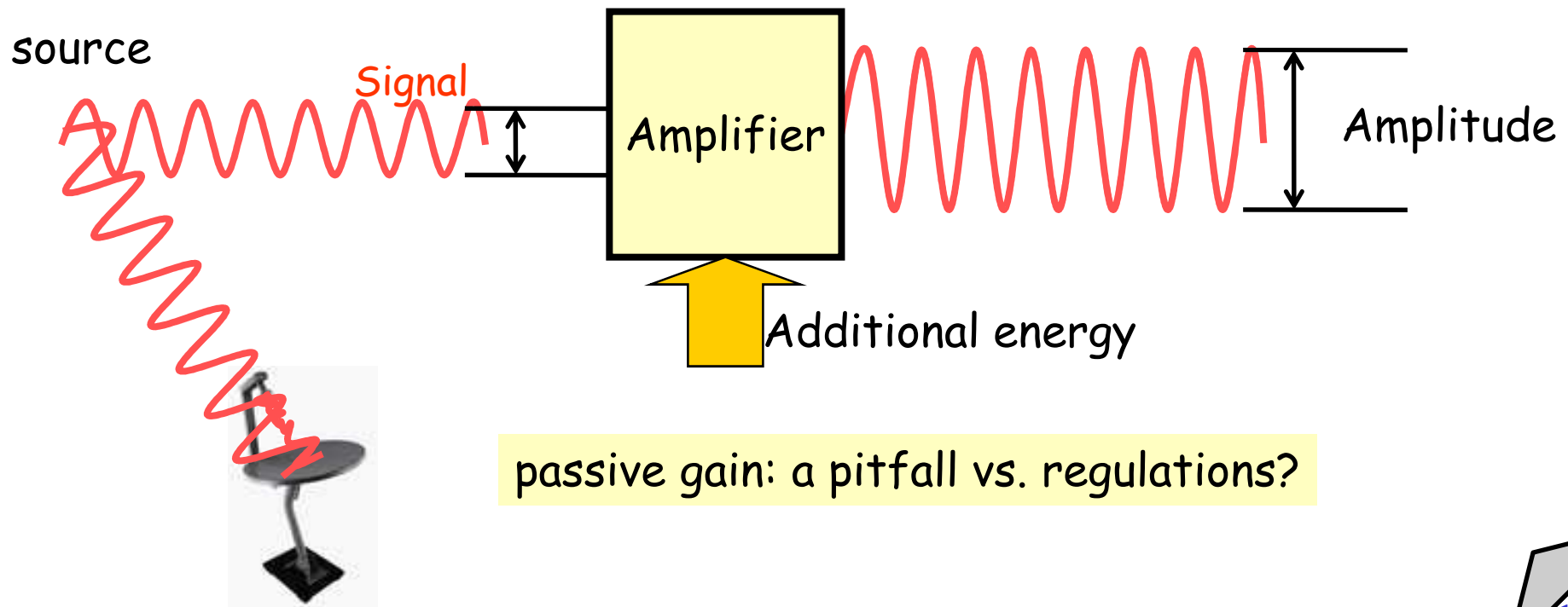

passive gain: a pitfall vs. regulations?



# Wireless transmission

- **Signal Loss: (Db)**
  - Decrease in amplitude **M** proportional to energy waste
    - Intentional (resistance, signal attenuation -> heat)
    - Obstacles, e.g. (walls, water for 2.4 Ghz) and distance (wireless)

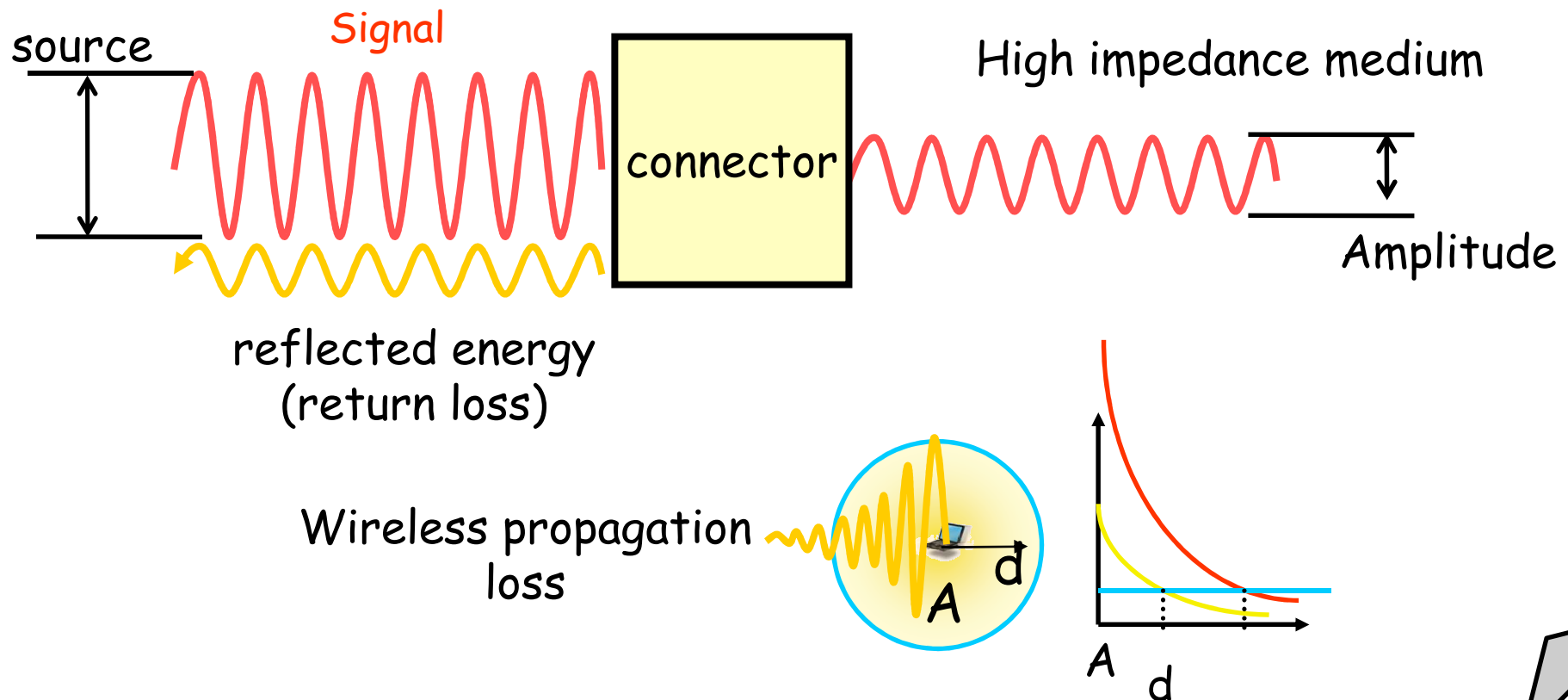

# Wireless signal propagation ranges

- **Transmission range**

- communication possible
- low error rate

- **Detection range**

- detection of the signal possible
- no communication possible

- **Interference range**

- signal may not be detected
- signal adds to the background noise

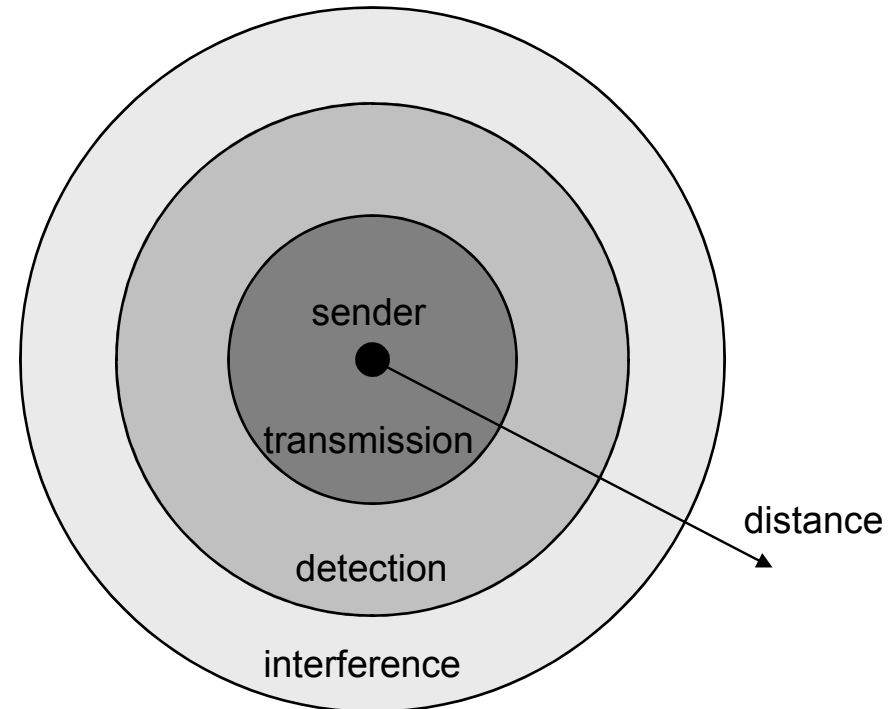

Ranges depend on receiver's sensitivity!

# Wireless Signal propagation effects

- Propagation in free space always like light (straight line)
- Receiving power proportional to  $1/d^2$   
( $d$  = distance between sender and receiver)
- Receiving power additionally influenced by
  - fading (frequency dependent)
  - shadowing
  - reflection at large obstacles
  - refraction depending on the density of a medium
  - scattering at small obstacles
  - diffraction at edges

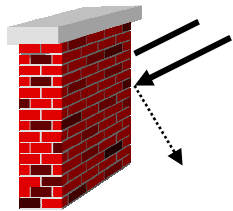

shadowing

© Luciano Bononi 2007

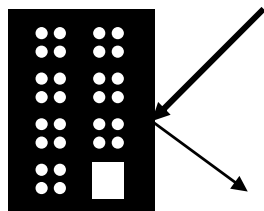

reflection

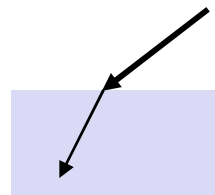

refraction

Sistemi e Reti Wireless



scattering



diffraction

# Real world example

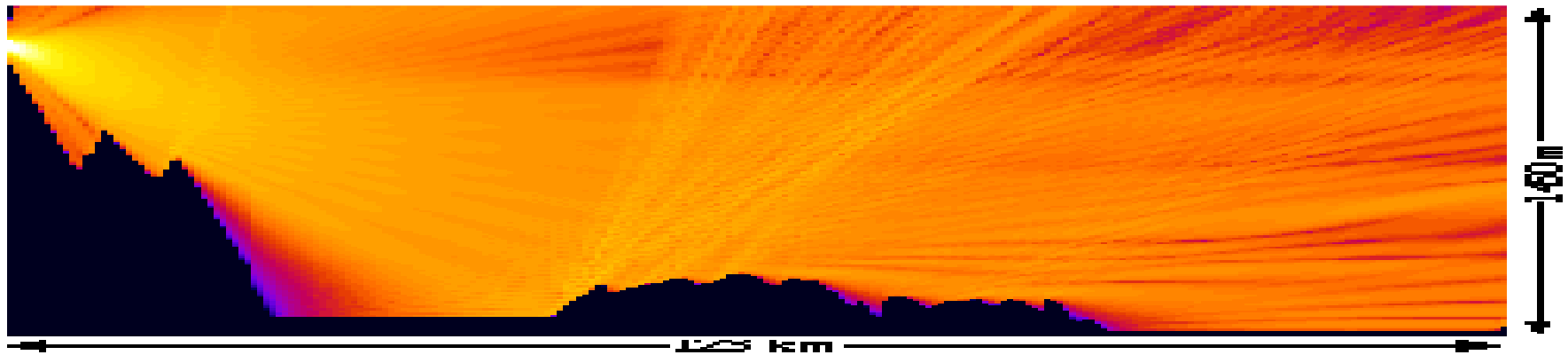

Raytracing examples

Low signal

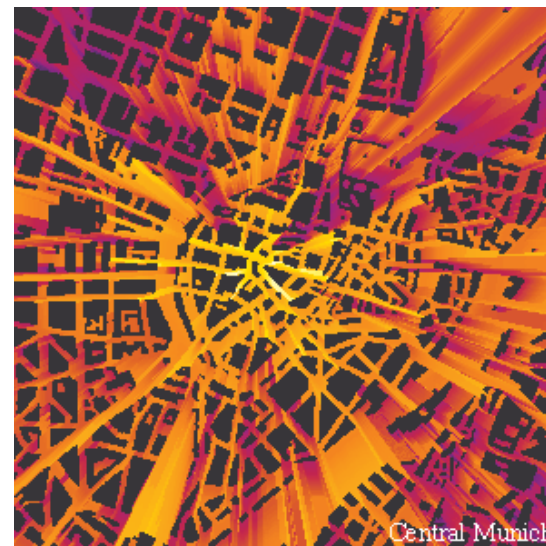
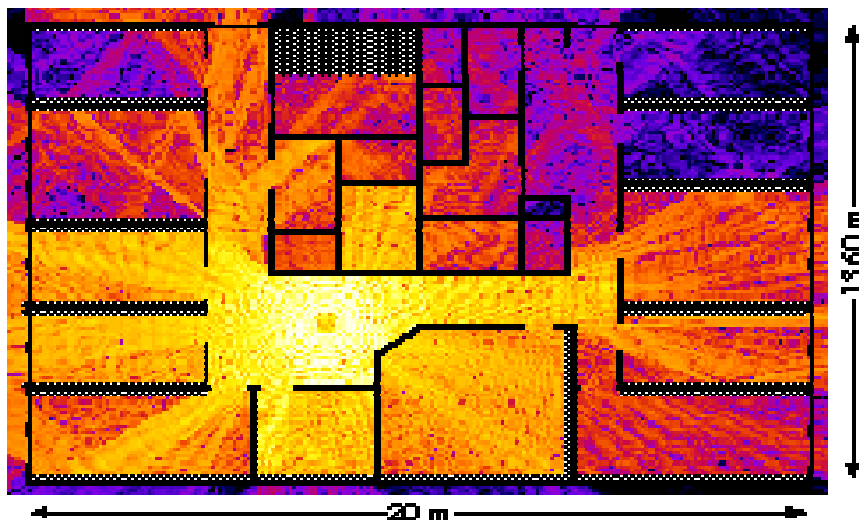

# Multipath propagation

- Signal can take many different paths between sender and receiver due to reflection, scattering, diffraction

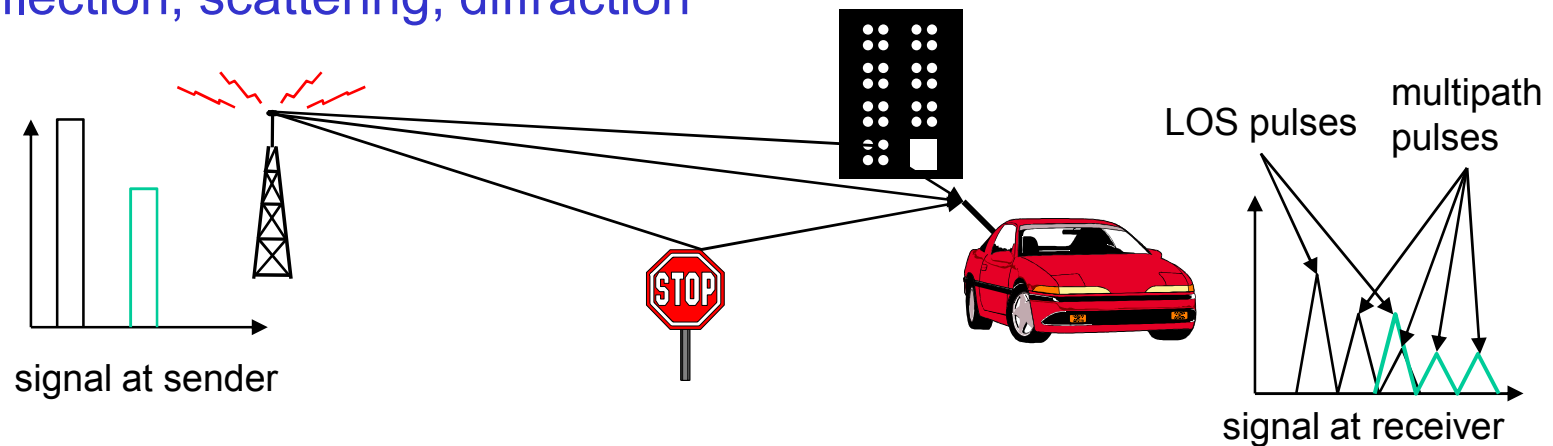

- Time dispersion: signal is dispersed over time  
→ interference with “neighbor” symbols, Inter Symbol Interference (ISI)
- The signal reaches a receiver directly and phase shifted  
→ distorted signal depending on the phases of the different parts

# Effects of mobility

- **Channel characteristics change over time and location**

- signal paths change
- different delay variations of different signal parts
- different phases of signal parts

→ **quick changes in the power received (short term fading)**

- **Additional changes in**

- distance to sender
- obstacles further away

→ **slow changes in the average power received (long term fading)**

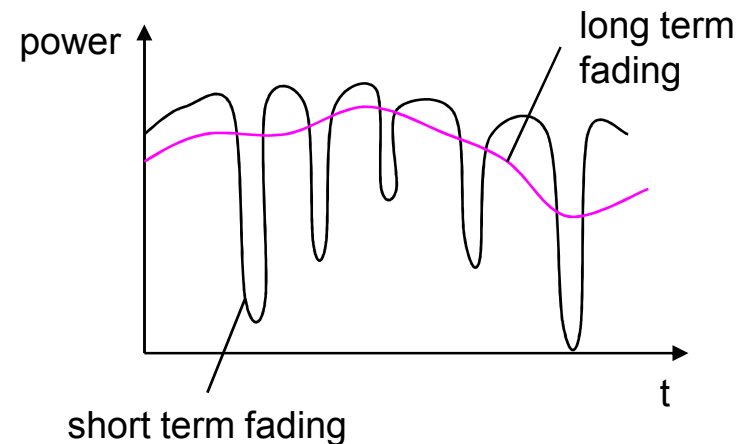

# Voltage Standing Wave Ratio (VSWR)

- **VSWR occurs with different impedance (Ohm) = resistance to AC current flow between transmitter and antenna**
  - VSWR is the cause of “return loss” energy towards the transmitter
  - Measured as ratio between impedance (before and after)
    - E.g. 1,5:1 (impedance ratio before/after is 1,5 times the ideal value)
    - 1 = normalized ideal impedance (1:1 means perfect VSWR)
  - VSWR Causes burnout of transmitter circuits, and unstable output levels

**VSWR solution:**  
always use same impedance  
circuits, cables, connectors  
(typical 50  $\Omega$  in LANs)

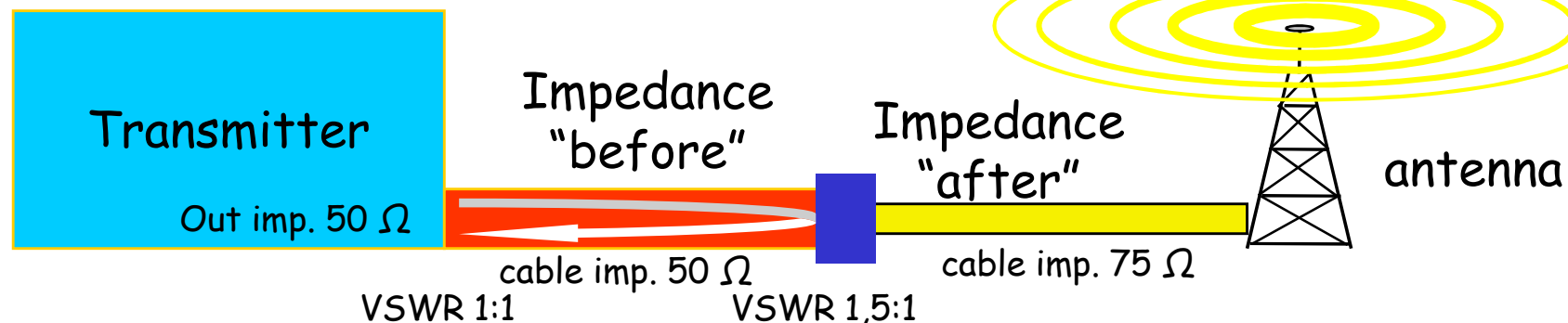

# Intentional radiator and EIRP

- (Intentional) radiator: (def.) RF device specifically designed to generate and radiate RF signals.
  - ...Includes Tx RF device, cables and connectors (antenna excluded)
  - IR Power output: (subject to regulations) is the power output of last connector just before the antenna
- Equivalent Isotropically Radiated Power (EIRP): the power radiated by the antenna (including the passive antenna gain effect of directional antennas)

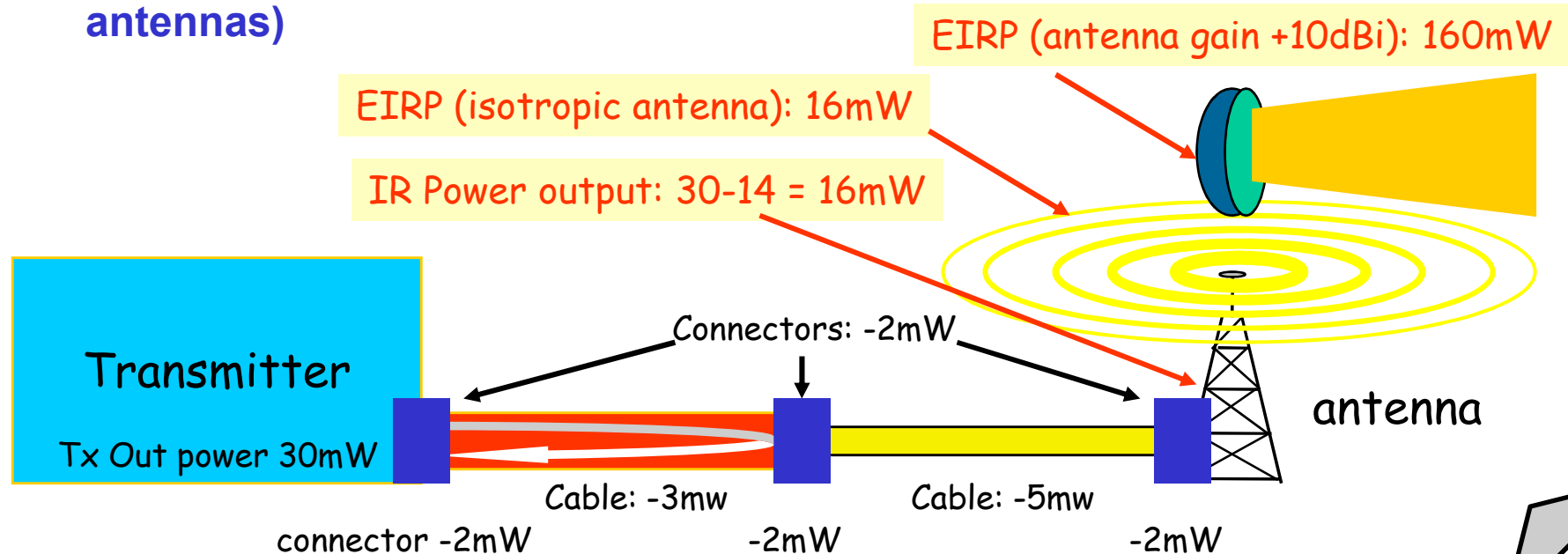



# System design (under power viewpoint)

- Many factors must be considered in the design of Wireless systems:
  - Power of transmitting device
  - Loss and gain of connectivity devices (cables, connectors, attenuators, amplifiers, splitters) between transmission device and transmitter's antenna
  - Power of the intentional radiator (last connector just before antenna)
  - Power radiated by antenna element (EIRP)
  - Propagation properties of the medium (attenuation before signal reception)
  - Loss and gain of connectivity devices (cables, connectors, attenuators, amplifiers, splitters) between receiver's antenna and receiver device.

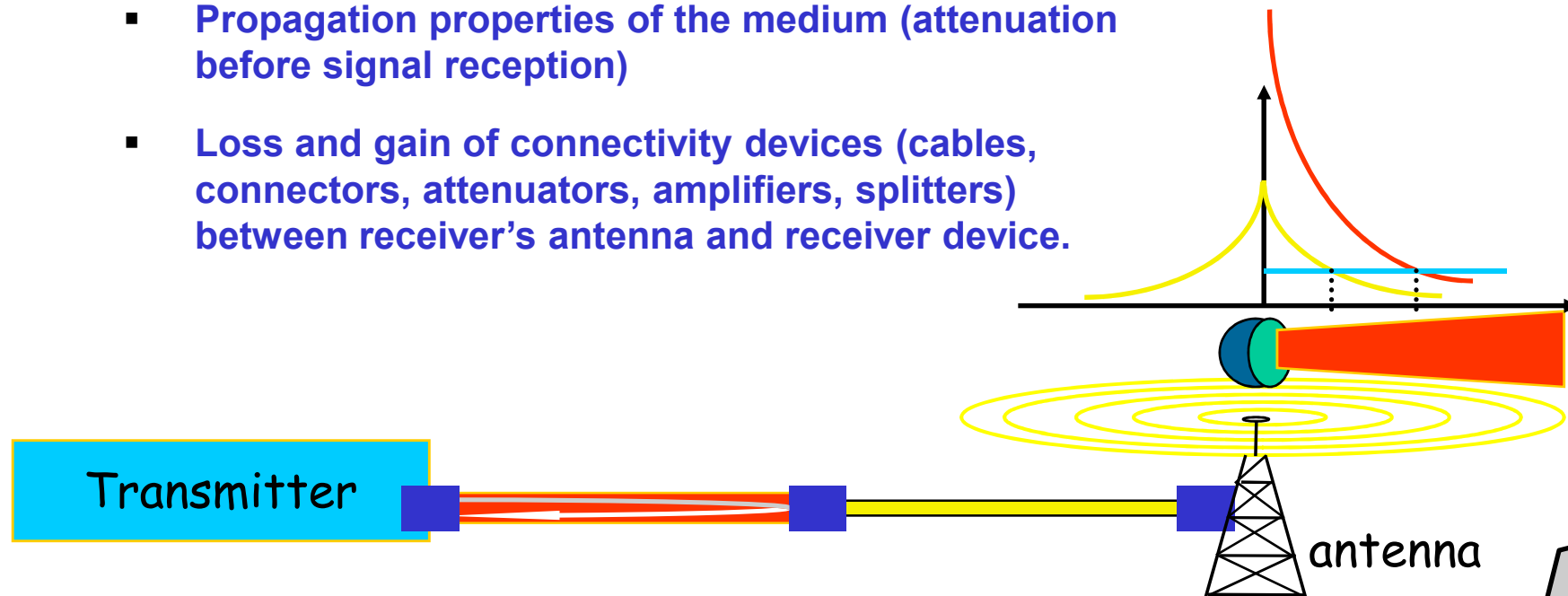

# Power measurement

---

- **WATT: electric power unit**
  - **1 Watt = 1 Ampere \* 1 Volt ( $P=V*I$ ) also  $P= R*I^2$  and  $P = L/t$** 
    - **Current (ampere) is the amount of charge (electrons) flowing as current in a wire**
    - **Voltage (Volt) is the “pressure” applied to the flow of charge**
    - **Resistance (impedance) is the obstacle to current flow**
    - **Power is the energy needed (in a given time unit) to apply a given “pressure” to a given “amount of charge”, by resulting in a flow of current.**
  - **Watt and dBm are units used for absolute power measurement**
  - **Typical RF power for WLANs:**
    - **AP: 30..100 mW (up to 250 mW outdoor), PCMCIA: 15..30 mW**

# Power measurement

- **Decibel (dB): a power measurement unit designed to express power loss**
  - It is more practical to use given the logarithmic decay of wireless signals
  - It allows to make easy calculations on “resulting power”
- **Decibel (dB) measures the logarithmic relative strength between two signals (mW are a linear absolute measure a energy)**

- $\text{Log}_{10}(X) = Y \iff 10^Y = X$

Exponential  
growth

- $1 = 10^0, \log_{10}(1) = 0$
- $10 = 10^1, \log_{10}(10) = 1$
- $100 = 10^2, \log_{10}(100) = 2$
- $1000 = 10^3, \log_{10}(1000) = 3$

Linear growth  
“BEL” units (B)

- **How strong is a 10 dB signal? (it depends on the reference signal)**

# Power measurement

- Decibel (dB): 1/10 of a Bel
- E.g. 1000 is one Bel greater than 100 => 1000 is 10 dB greater than 100

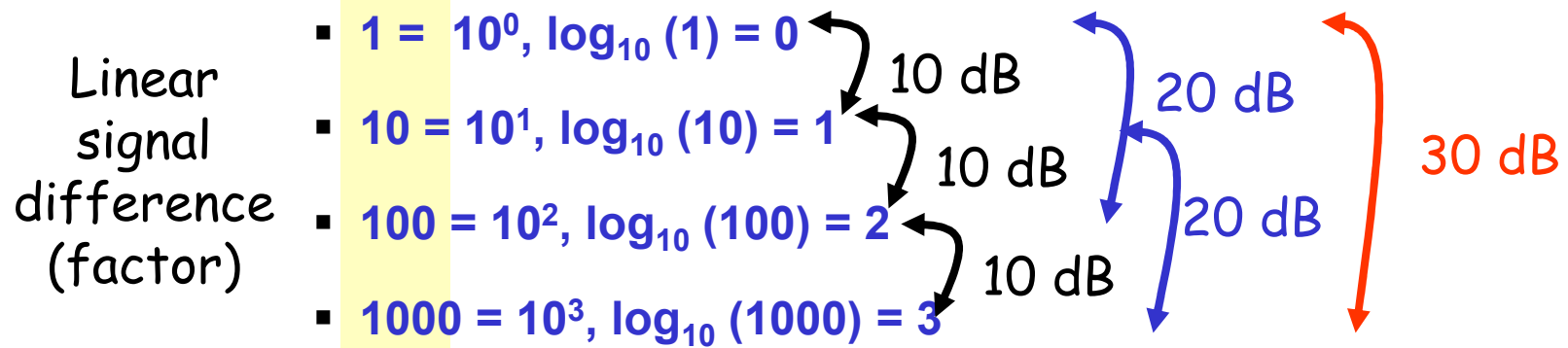

- How strong is a 10 dB signal? (it depends on the reference signal)
  - Positive dB value is power gain, negative dB value is power loss
  - e.g. given 7 mW power, a +10 dB signal gain is 70 mW
  - e.g. given 7 mW power, a -10 dB signal gain (loss) is 0.7 mW
- Power Difference (in dB) between Tx and Rx signal:
  - Power Difference (dB) =  $10 * \log(\text{Power Tx(Watt)} / \text{Power Rx (Watt)})$
- Gain and Loss are relative power measurements: dB is the unit

# Power measurement

- **Advantage of dB: what is better?**
  - **E.g.: A signal transmitted at [TX] 100 mW is received at [RX] 0.000005 mW**
    - **Power Difference (dB) =  $10 * \log([RX] / [TX]) = 10 * \log(0.000005\text{mW}/100\text{mW}) = -73$**
    - **A signal transmitted at 100 mW is received with gain (loss) -73 dB**
- **Advantage of dB: what is better?**
  - **E.g.: A signal transmitted at 100 mW is received at 0.000005 mW, then it is amplified (\*100) to 0.0005 mW ..... ???**
  - **A signal transmitted at 100 mW is received with gain (loss)  $-73+20= -53$  dB**

<b>-3 dB</b>	<b><math>\frac{1}{2}</math> power in mW (/ 2)</b>
<b>+3 dB</b>	<b>2x power in mW (* 2)</b>
<b>-10 dB</b>	<b>1/10 power in mW (/ 10)</b>
<b>+10 dB</b>	<b>10x power in mW (* 10)</b>

Approximated table (values defined for ease of calculations)

# Power measurement

- **Practical example:**
  - Signal Tx at 100 mW, cable **-3dB** loss, amplifier **+10 dB** gain
    - $100 \text{ mW} / 2 (-3\text{dB}) = 50 \text{ mW} * 10 (+10 \text{ dB}) = 500 \text{ mW}$  IR power output
  - Signal TX at **30 mW** is received at the antenna as **6 mW (2/10 of TX power)**
    - Intentional Radiator Gain (loss) =  $30\text{mW} / 10 = 3\text{mW} * 2 = 6 \text{ mW}$
    - Intentional Radiator Gain (loss) =  $-10 \text{ dB} + 3 \text{ dB} = -7 \text{ dB} (\approx 1/5, 7\text{dB} \approx 5\text{x})$
- **N.B. dBs are additive measures** of gain (loss): e.g.  $6\text{dB} = +3+3 \text{ dB}$ ,  $7\text{dB} = 10-3 \text{ dB}$ 
  - E.g.  $100 \text{ mW} -6 \text{ dB} = 100 \text{ mW} -3 -3 \text{ dB} = 100 / 2 / 2 = 25 \text{ mW}$
  - E.g.  $100 \text{ mW} +7 \text{ dB} = 100 \text{ mW} +10 -3 \text{ dB} = 100 * 10 / 2 = 500 \text{ mW}$
  - E.g.  $10 \text{ mW} + 5 \text{ dB} = 10 \text{ mW} (+10+10-3-3-3-3-3)\text{dB} = 1000/32 = 31.25 \text{ mW}$
  - E.g.  $10 \text{ mW} + 11 \text{ dB} = ?$
  - E.g.  $50 \text{ mW} - 8 \text{ dB} = ?$

N.B. Approximated values (values defined for ease of calculations)

# Power measurement

- **dBm: dB-milliWatt, the absolute measure of signal power**
  - Assumption: reference signal is 1 mW = 0 dBm(normalization factor)
  - Useful for gain/loss calculation without passing through mW
    - E.g. access point transmits 100 mW = 1mW (\*10\*10) =+20 dBm
    - PCMCIA card transmits at 30 mW = 1mW (\*10\*3) = +14.7 dBm
  - E.g. Tx= 30 mW, cable –2 dB, amplifier +9 dB:
    - 30 mW = 1mW \*10 \*3 = 14.7 dBm
    - IR power : 14.7 dBm –2dB +9dB = 21.7 dBm (147.91 mW)
  - In general, for converting mW to dBm and viceversa:
    - $P_{\text{dBm}} = 10 \log(P_{\text{mW}})$  and  $P_{\text{mW}} = 10^{(P_{\text{dBm}} / 10)}$

# Power measurement

- **mW - dBm: conversion table**

-40 dBm	-30 dBm	-20 dBm	-10 dBm	0 dBm	+10 dBm	+20 dBm	+30 dBm	+40 dBm
100 nW	1 μW	10 μW	100 μW	1 mW	10 mW	100 mW	1 W	10 W

-12 dBm	-9 dBm	-7 dBm	-6 dBm	-3 dBm	0 dBm	+3 dBm	+6 dBm	+7 dBm	+9 dBm	+12 dBm
62,5 μW	125 μW	200 μW	250 μW	500 μW	1 mW	2 mW	4 mW	5 mW	8 mW	16 mW



# Power measurement

- **dBi: dB-isotropic**, the normalized measure of antenna passive gain
  - Assumption: an isotropic radiator has 100% efficiency in radiating energy in uniform way in every direction (e.g. the Sun)
  - Antennas concentrate energy in non-isotropic way, resulting in **passive gain (space dependent)**. Ideal antenna: zero length dipole

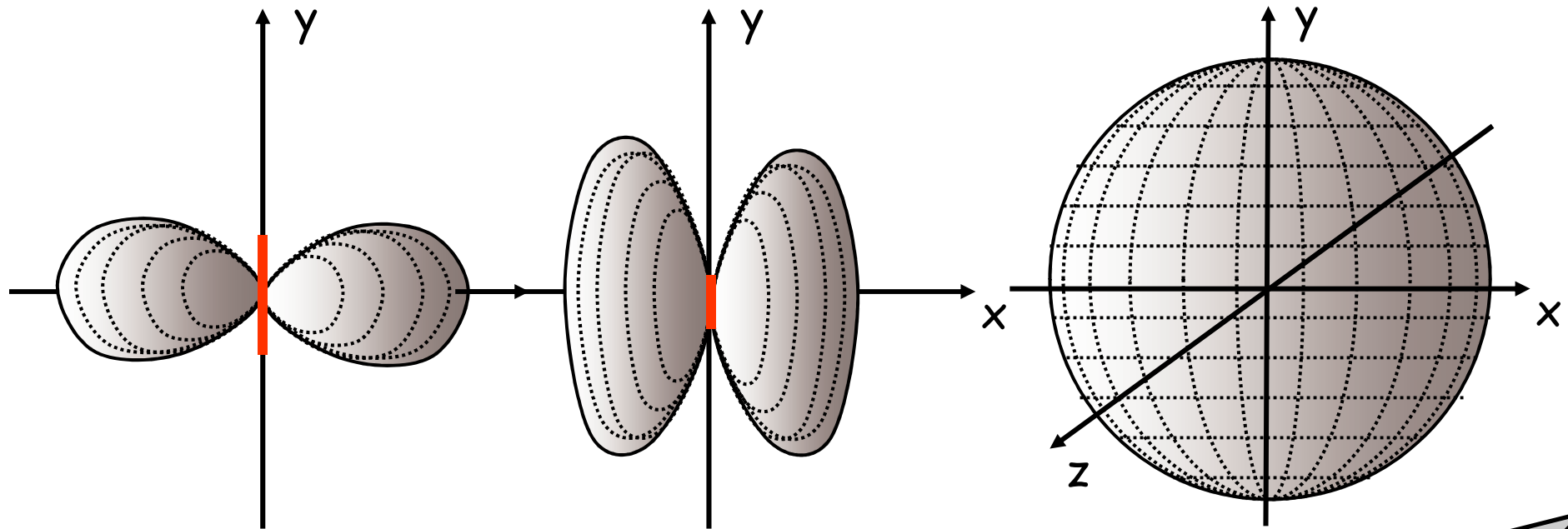

# Power measurement

- **dBi: dB-isotropic**, the normalized measure of antenna passive gain
  - If an antenna located in the origin  $(0,0,0)$  has twice the radiated energy of an isotropic radiator in a given point  $(x,y,z)$ , then the antenna gain in  $(x,y,z)$  can be defined as +3 dBi. If the energy is 10x the isotropic radiator, the gain is +10 dBi, etc.etc.
  - Q: If the antenna gain is 7 dBi in  $(x,y,z)$ ?

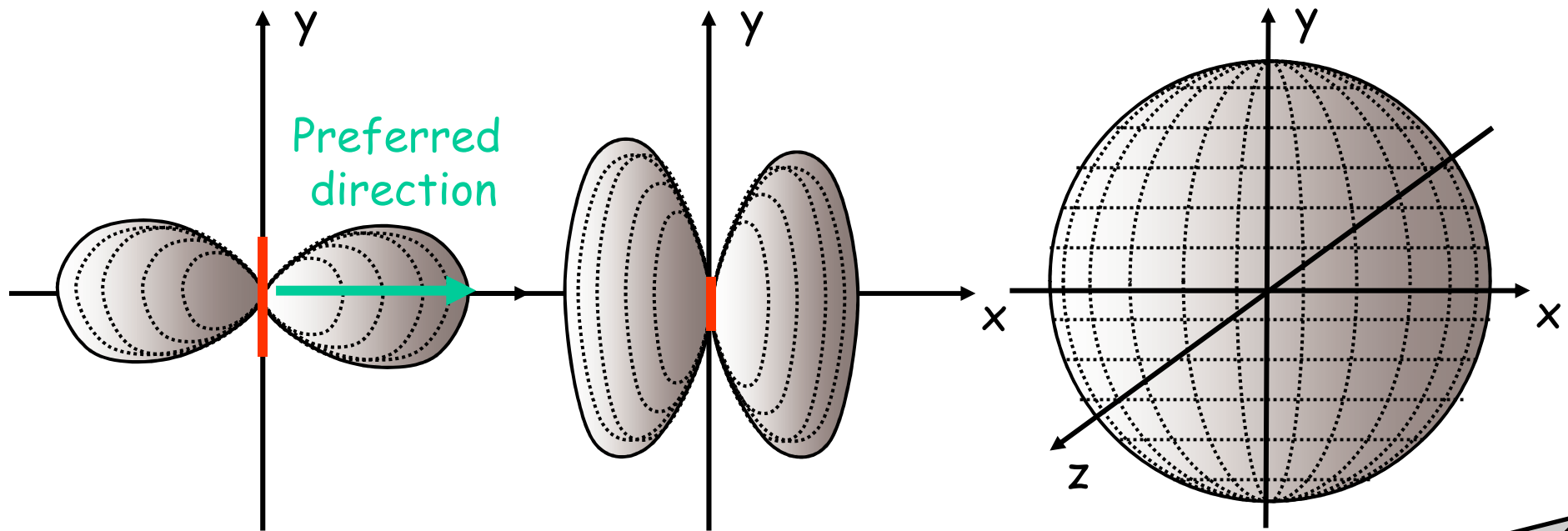

# Power measurement

- **dBi: dB-isotropic, the normalized measure of antenna passive gain**
  - Real antennas always have a preferred direction where the power is greater than isotropic radiator: **gain is always positive in the preferred direction!**
  - **Example: 1 mW IR power applied to directional antenna with +10 dBi gain in the preferred direction, would translate in EIRP?**
    - **EIRP = 1mW + 10 dBi = (10x) = 10 mW EIRP**

N.B. this does not mean that antenna generates more power!  
Antenna concentrates power in preferred direction.

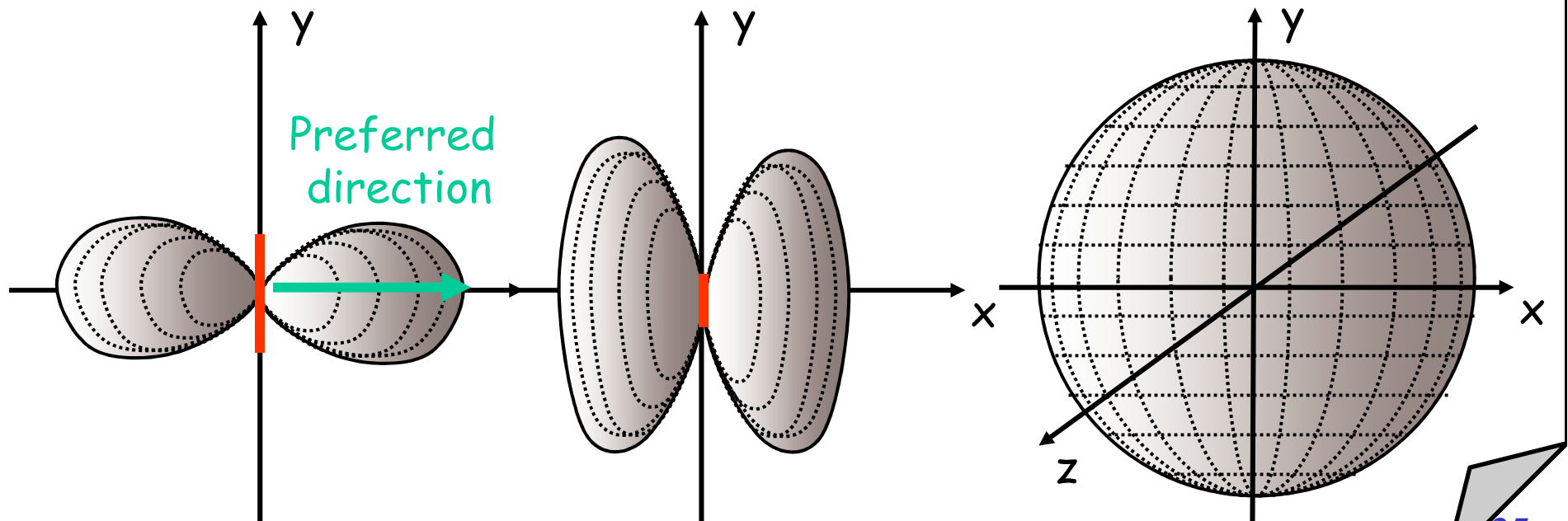

# Power measurement

- **dBd: dB-dipole, the normalized antenna passive gain vs. 2,14 dBi half-wave dipole**
  - Reference is a half wave dipole with 2.14 dBi gain in **preferred direction!**
  - **Conversion rule:**
    - **0 dBd = 2.14 dBi,      dBd = (dBi - 2.14),      dBi = (dBd + 2.14)**

Reference dipole

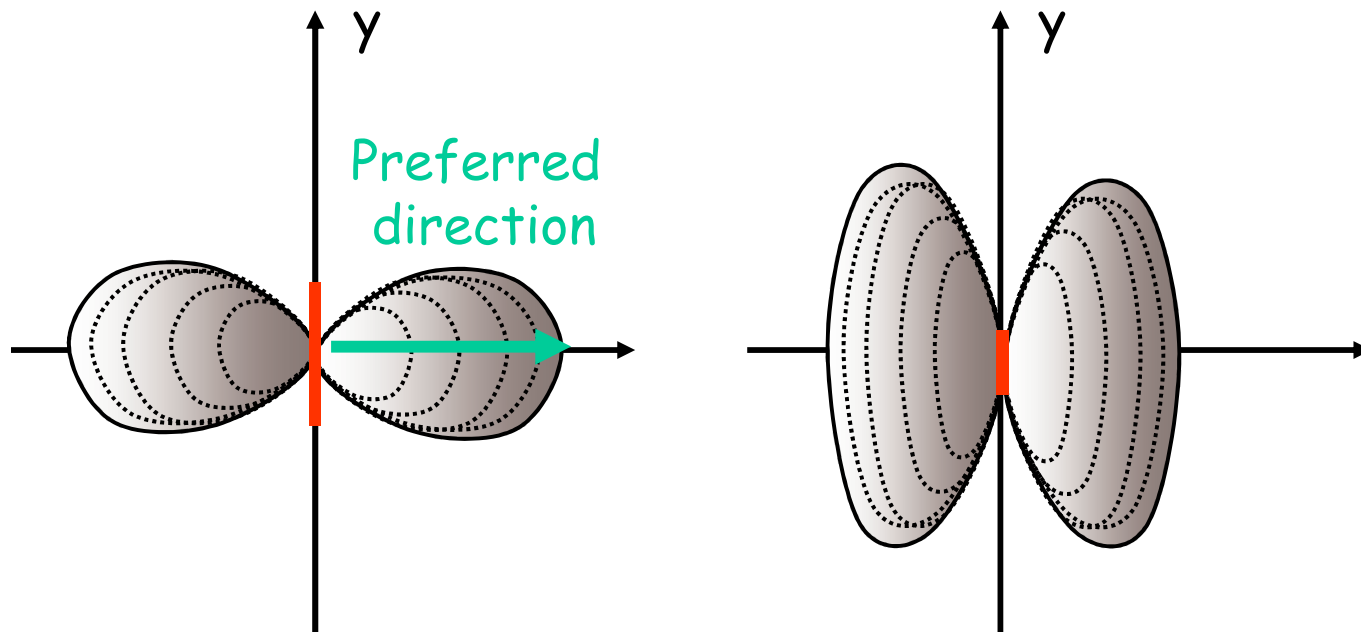

# Power monitoring (e.g. IEEE 802.11 devices)

- (received) Power monitoring in IEEE 802.11 devices is needed for making device driver to work properly (typical sensitivity range is  $[-90..+10]$  dBm):
  - Detect signal (below or above the sensitivity threshold?)
  - Detect signal power (selection of coding technique... That is bitrate!)
  - Detect channel status: idle? Ok, transmit! Busy? Ok, wait.
- Received Signal Strength Indicator (RSSI)
  - Index defined for IEEE 802.11 devices (check device analyzer, if any)
  - RSSI = function (dBm or mW received) = pure number reported to device driver!
  - Unfortunately the RSSI scale is not standard, that is, device dependent!
    - This fact does not allow to compare if device A receives better than device B (assuming different manufacturer) based on RSSI measurement
  - Problem: device A indicates maximum RSSI=255 (8 bits) with  $-10$  dBm signal (0.1 mW), and device B indicates maximum RSSI=32 (5 bits) with  $-15$  dBm (0.03 mW). Q: when both A and B in (x,y,z) receive  $-15$  dBm, which one is better device? That is, which one would you buy if you are a system admin?

# Antennas

---

- **Illustration of general issues**
  - **Convert electrical energy in RF waves (transmission), and RF waves in electrical energy (reception)**
  - **Size of antenna is related to RF frequency of transmission and reception**
  - **Shape (structure) of the antenna is related to RF radiation pattern**
- **Radiation patterns of different antenna types**
- **Positioning antennas**
  - **Maximum coverage of workspace**
  - **Security issues**
- **Real antenna types: omni-directional, semi-directional, highly-directional**

# Omnidirectional antenna

- **Omni-directional antenna: radiates RF power equally in all directions around the vertical axis.**
- **Most common example: dipole antenna (see Access Points)**
  - See how to make it (**disclaimer: do not try this at home**):  
<http://www.nodomainname.co.uk/Omnicolinear/2-4collinear.htm>  
<http://www.tux.org/~bball/antenna/>
  - Info & fun: <http://www.wlan.org.uk/antenna-page.html>
  - More info: <http://www.hdtvprimer.com/ANTENNAS/types.html>



TV dipole

Q: Why TV dipole is bigger?  
A: 100 Mhz vs. 2.4 Ghz



AP dipole

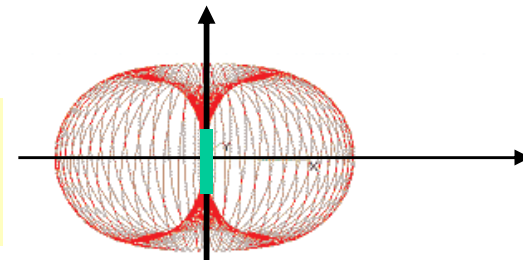

# Omnidirectional antennas: simple dipoles

- Real antennas are not isotropic radiators but, e.g., dipoles  
→ shape of antenna proportional to wavelength

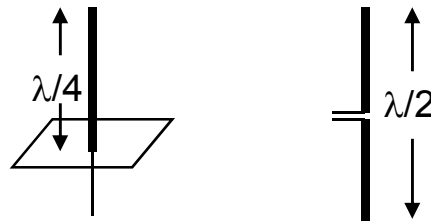

- Example: Radiation pattern of a simple Hertzian dipole

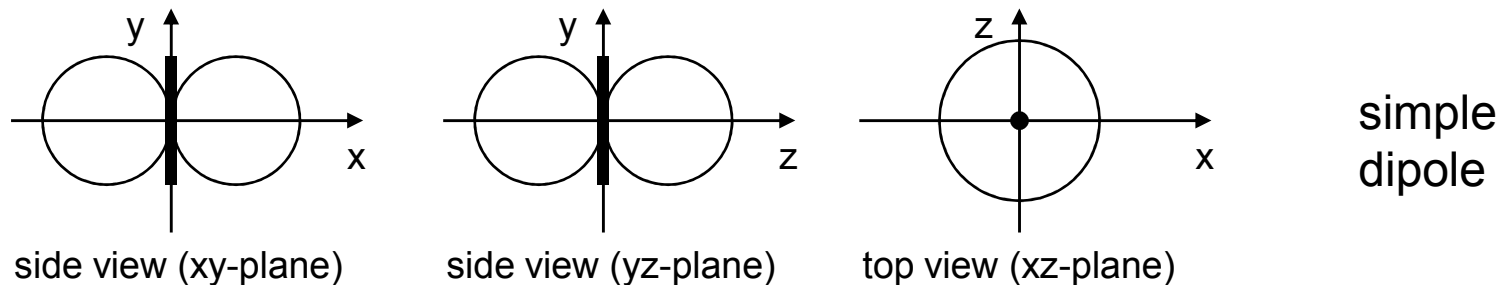

- Gain: maximum power in the direction of the main lobe compared to the power of an isotropic radiator (with the same average power)



# Omnidirectional antennas: simple dipoles

- Dipole: passive gain is due to concentration (shape) of radiation

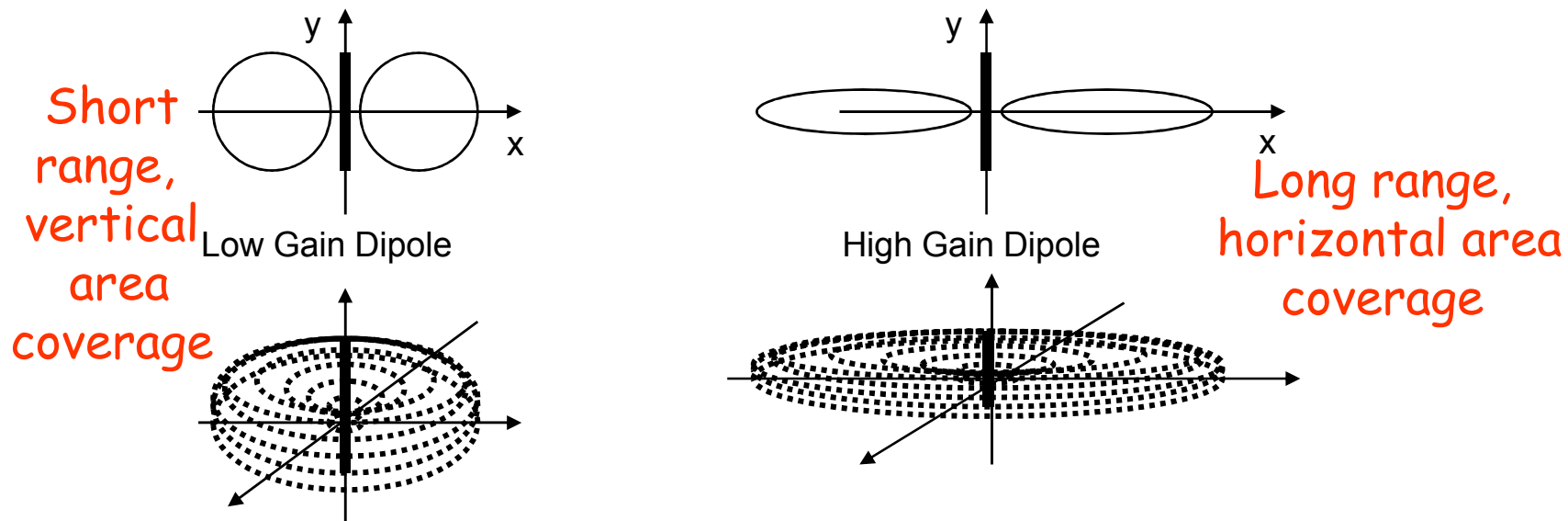

- Dipole: active gain is obtained with power amplifiers (needs external source of energy)
- N.B. near (below) the dipole the signal is weak! And better radiation is obtained in sub-areas around the dipole!

# Omnidirectional antennas: simple dipoles

- **Problem: how and when to mount omidirectional antennas?  
And which gain is ok?**

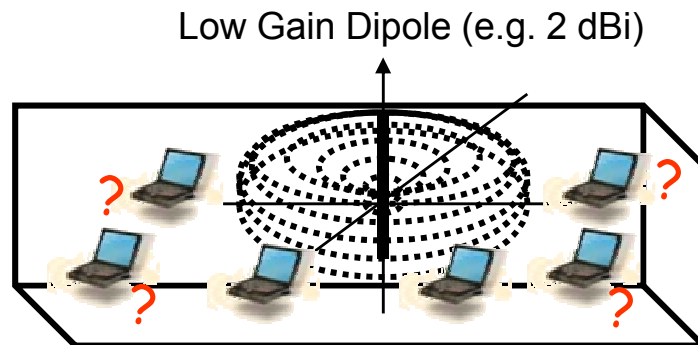

Room A

High Gain Dipole (e.g. 8..10 dBi), very flat coverage  
low signal in the proximity of the antenna

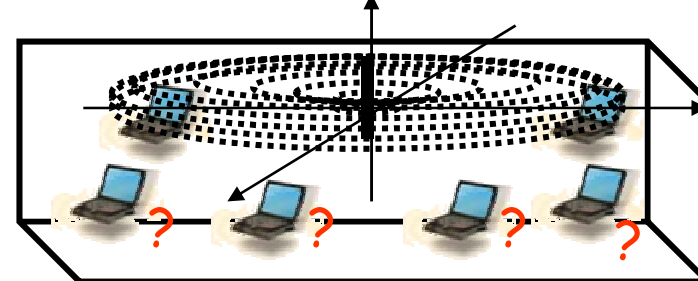

Room B

- **How: Ceiling? Wall? Client positions? Area? Many factors influence the planning...**
- **When:**
  - need for uniform radio coverage around a central point
  - **Outdoor: point-to-multipoint connection (star topology)**

# Omnidirectional antennas: simple dipoles

- **Antenna Tilt:** degree of inclination of antenna with respect to perpendicular axis

High Gain Dipole (e.g. 8..10 dBi), very flat coverage mounted on the ceiling

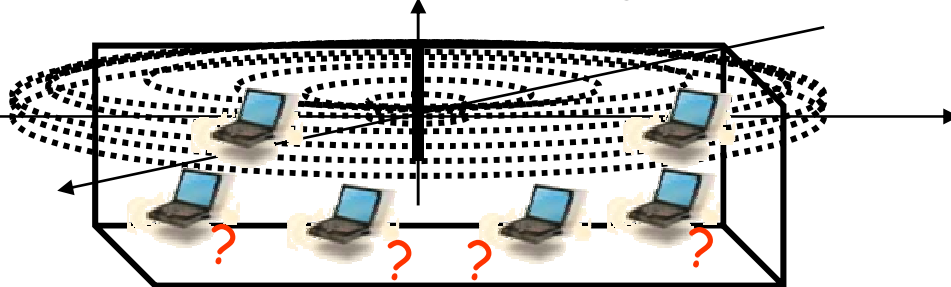

Room A

High Gain Dipole (e.g. 8..10 dBi), very flat coverage mounted on the ceiling with downtilt

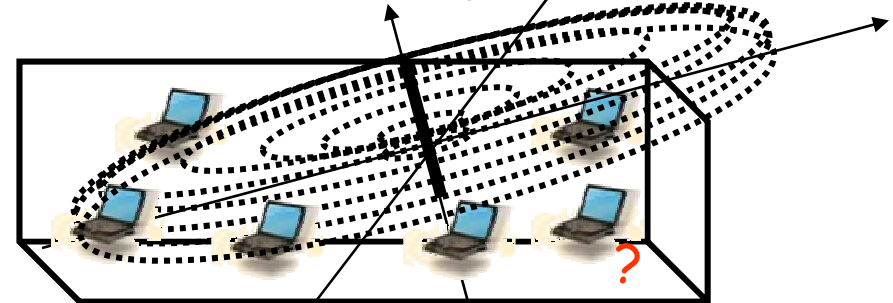

Room B

- Some antennas allow a variable degrees **downtilt**.
- Half signal disperded “in the sky”, 2<sup>nd</sup> half better exploited.

# Semi-directional antennas

- Patch (flat antennas mounted on walls)
- Panel (flat antennas mounted on walls)
- Yagi (rod with tines sticking out)

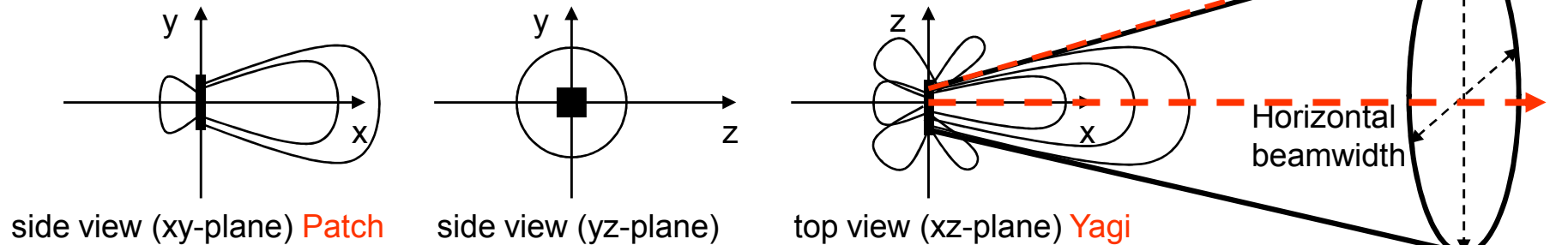

Semi-directional antenna

Beamwidth cone:  
-3dB signal boundary off-axis

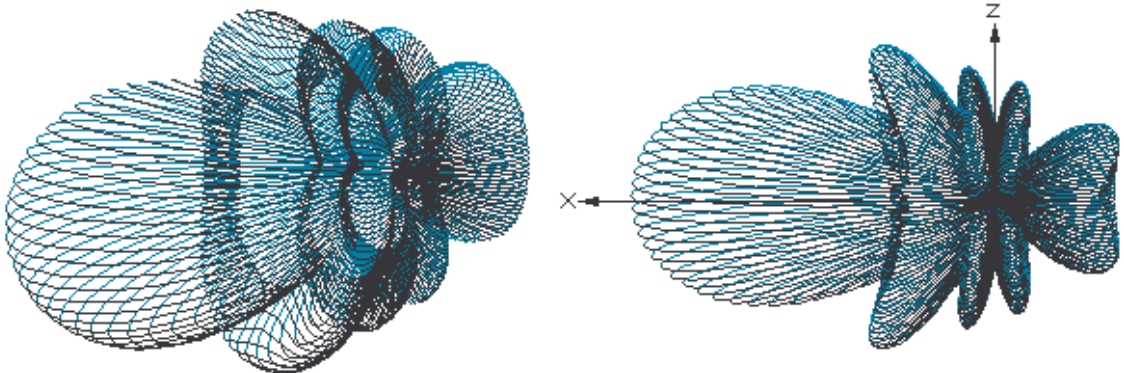

Credits: <http://www.hdtvprimer.com/ANTENNAS/types.html>

# highly-directional antennas

- Parabolic Dish
- grid

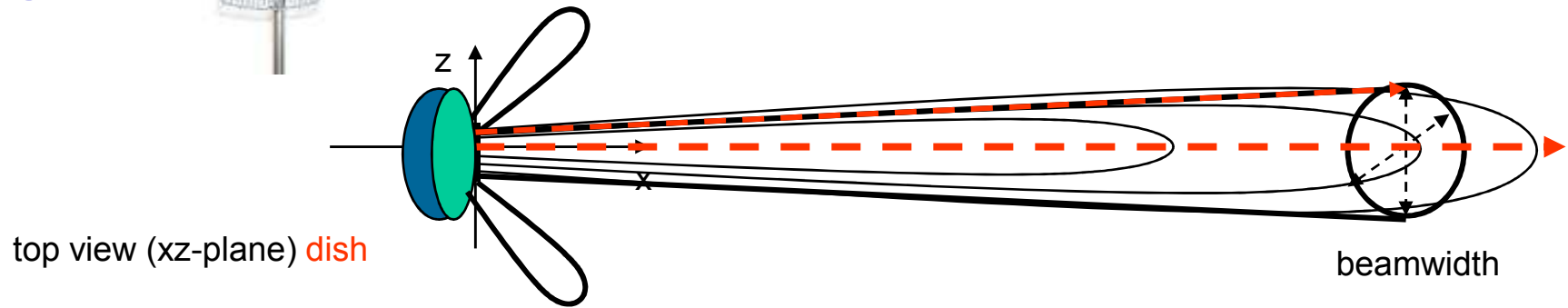

Antenna type	H beamwidth	V beamwidth
Omni-dir.	360°	7°.. 80°
Patch/panel	30° .. 180°	6° .. 90°
Yagi	30° .. 78°	14° .. 64°
Parabolic dish	4° .. 25°	4° .. 21°

Semi-directional antenna

Beamwidth cone:  
-3dB signal boundary  
off-axis

# highly-directional antennas

- Common use: Point-to-point link
- Out of beam alignment

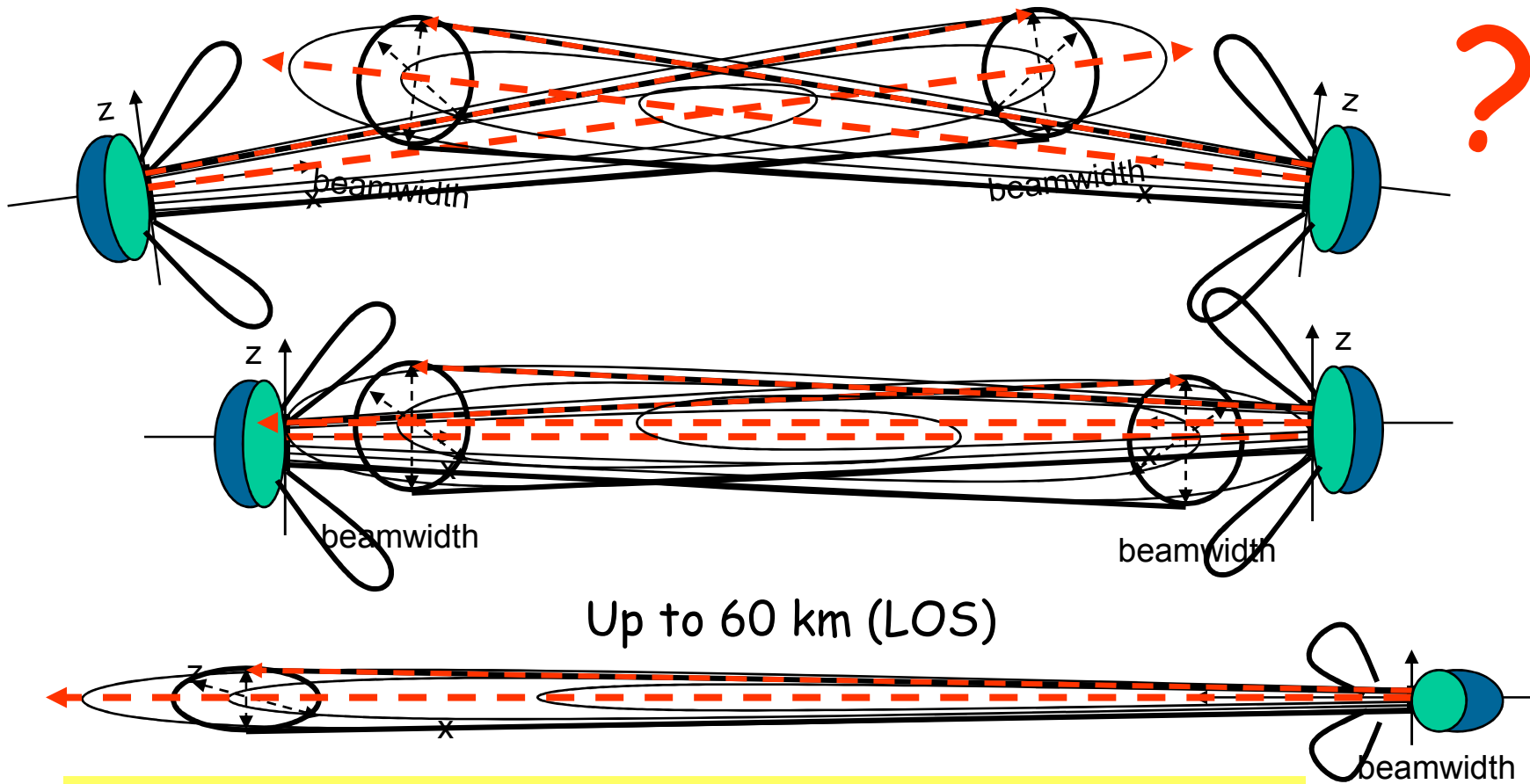

Wind effect: better to have lower gain and wider beam

# highly-directional antennas

- **Line of sight (LOS):**
  - Straight line between transmitter and receiver
  - No obstructions (outdoor long range reduces reflections)
    - Polarization is more important than in indoor scenarios
- **Fresnel Zone: RF is not laser light, RF signals diffuse energy in space**
  - Ellipse shaped area centered on the LOS axis
  - Most additive RF signal is concentrated in the Fresnel Zone
  - It is important that Fresnel Zone is free from obstacles

Red zone:  
additive phase signal

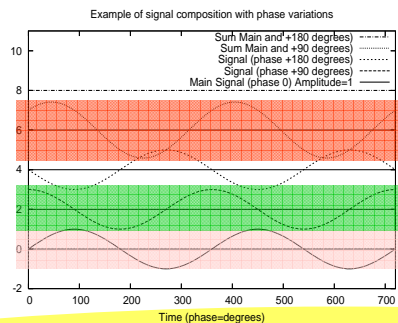

Yellow zone:  
inverse phase signal

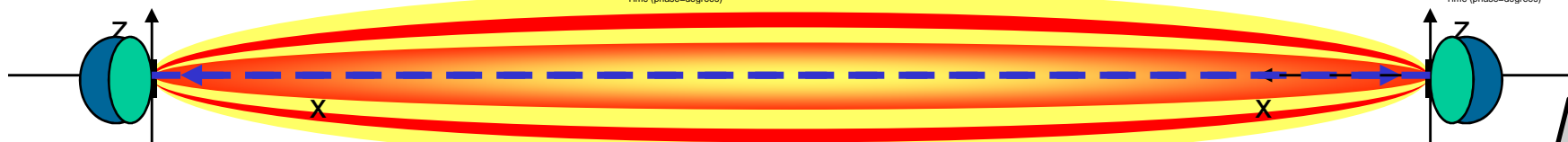
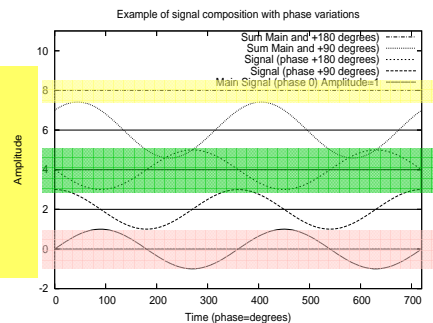

# highly-directional antennas

## ▪ Fresnel Zone (FZ)

- Blockage of Fresnel Zone causes link disruption
  - Caused by buildings, (growing) trees, foliage, etc.
  - Rule of thumb: < 20% obstruction of Fresnel Zone
  - Practical rule: calculate the radius of FZ leaving 60% unobstructed radius

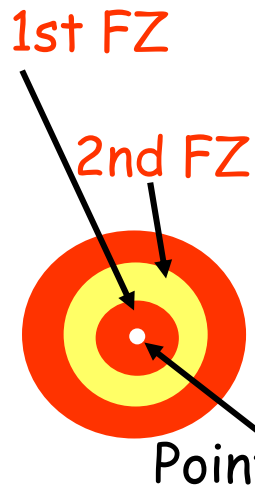

$$- R_{60\%} = 43.3 \times \sqrt{(d/4f)}$$

R=radius of 60% central FZ (feet)  
d=distance(Miles), f=freq (GhZ)

$$- R_{100\%} = 72.2 \times \sqrt{(d/4f)}$$

R=radius of 100% FZ (feet)  
d=distance(Miles), f=freq (GhZ)

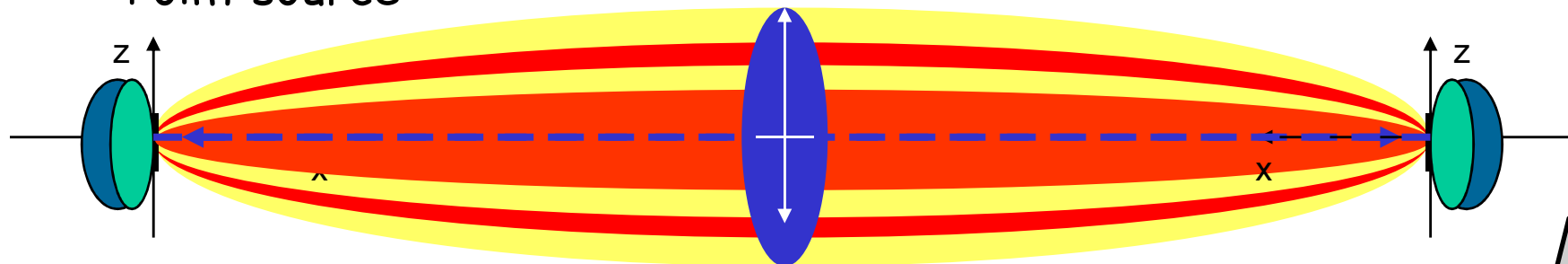



# highly-directional antennas

- **Fresnel Zone (FZ)**

- N.B. the FZ radius depends only on the distance  $d$  between antennas, and frequency  $f$  of RF signal!
- Type of antenna, beam width (degree), and gain (dBi) have no effects!
  - E.g. +13 dBi Yagi (30 degree beam) vs. +24 dBi Dish (5 degrees) have the same FZ!!!!
- **In practice: if FZ is partially obstructed, it is not useful to use higher gain antennas (with small degree beam) !!!**

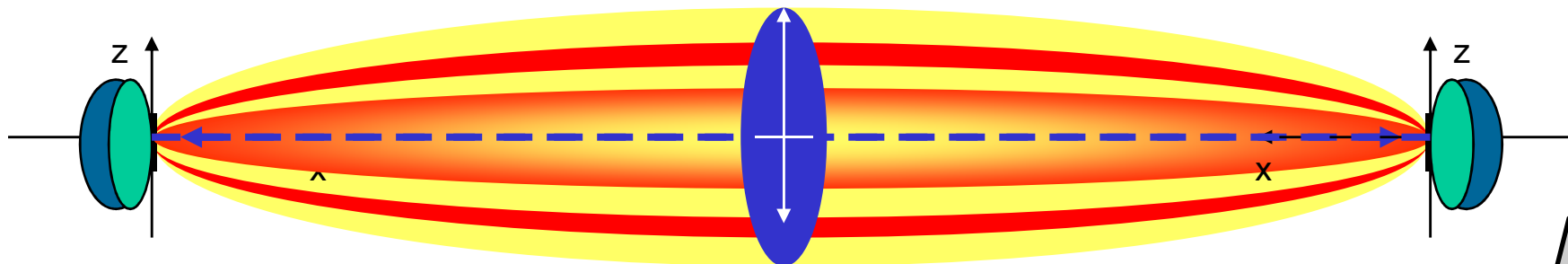

# highly-directional antennas

- **Fresnel Zone (FZ)**
  - Is not relevant in indoor scenarios (due to reflections...)
- **Consider the Earth bulge!!!**
  - Very long point-to-point connections may have more than 40% FZ obstructed by Earth surface! Earth Bulge height =  $h$  (feet) =  $D^2/8$
  - Minimum antenna height (link > 7 miles)  $H = (43.3 \sqrt{D/4F}) + D^2/8$

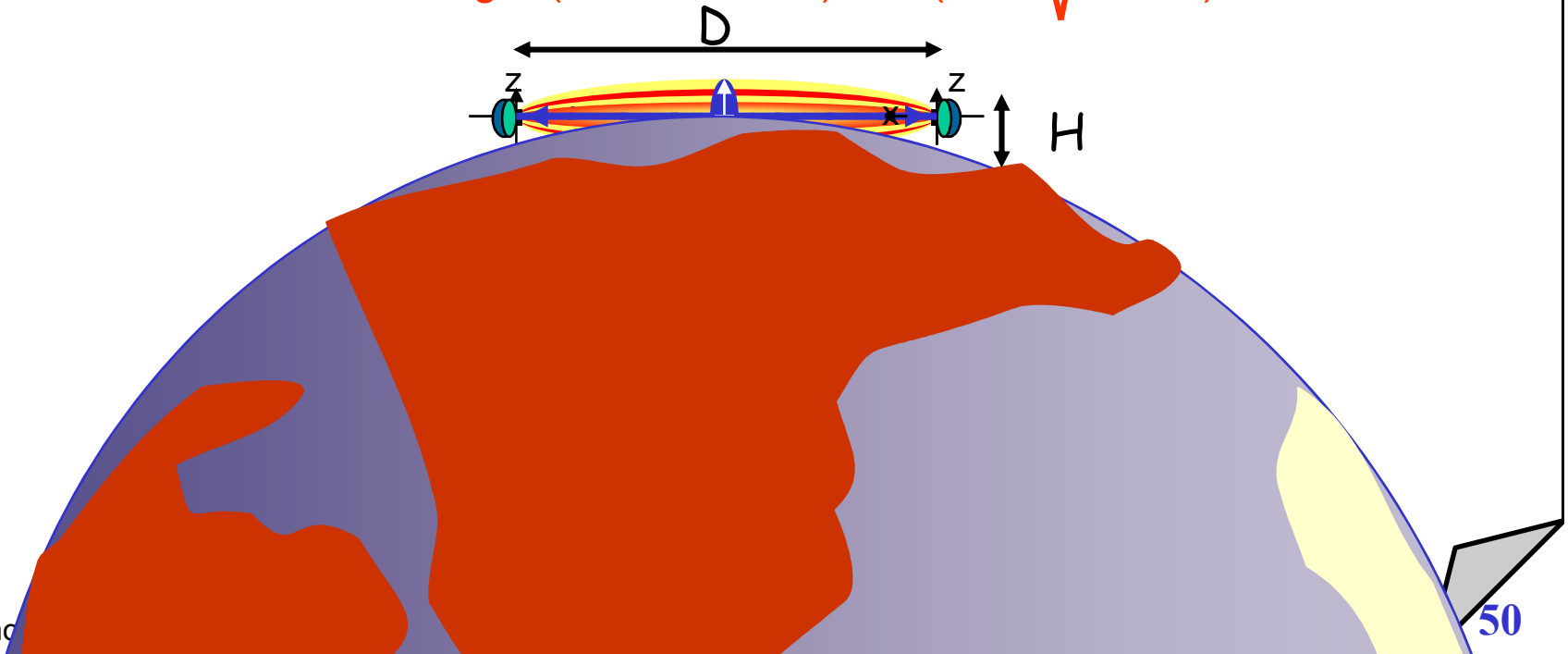

# Sectorized-directional antennas

- **Arrays of sectorized directional antennas**

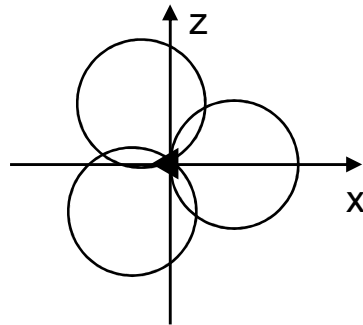

top view, 3 sector

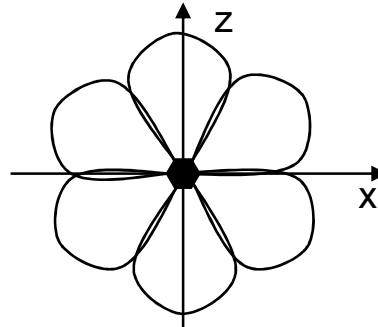

top view, 6 sector

sectorized  
antenna

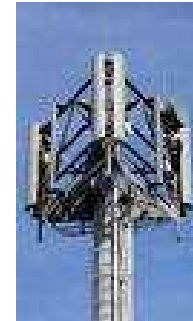

- **Space multiplexing (channel reuse)**

# Azimuth and Elevation antenna charts

## Charts for understanding antenna coverage pattern

- **Azimuth chart** (pattern seen from front/right/behind/left)
  - Obtained with spectrum analyzer with central antenna frequency
  - Signal measured in dB around the antenna
    - E.g. Dipole pattern: almost circular
    - E.g. yagi pattern: high in front, low beside
- N.B. distance and Tx power is not relevant (signal strength in a location is relative to every other location in the chart, like with dB)
- **Elevation chart** (pattern seen front/below/behind/above)

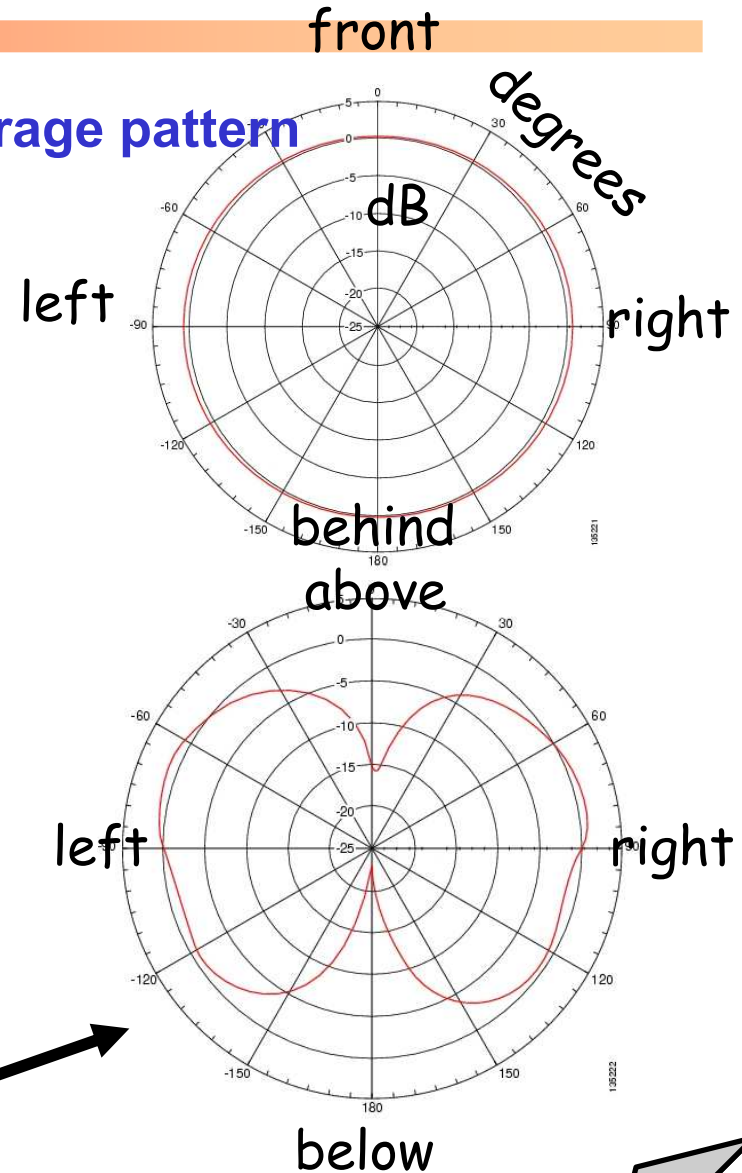

# Antennas: diversity

- **Grouping of 2 or more antennas**
  - multi-element antenna arrays
- **Antenna diversity**
  - switched diversity, selection diversity
    - receiver chooses antenna with largest output
  - diversity combining
    - combine output power to produce gain
    - cophasing needed to avoid cancellation (phased antenna array... Requires processor)

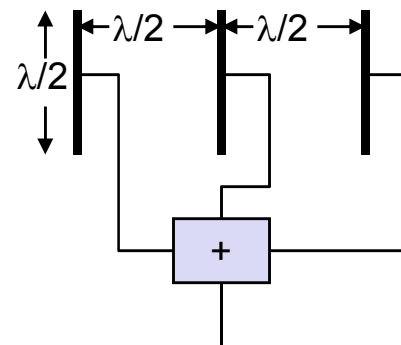
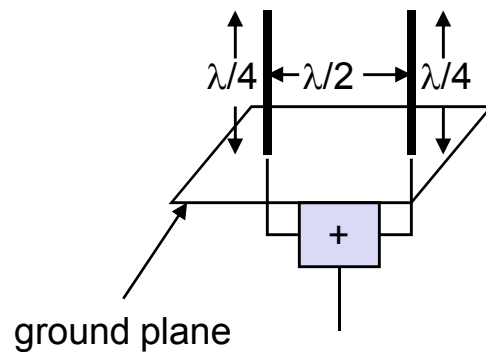

# Path Loss

- **Path Loss: RF signal “dispersion” (attenuation) as a function of distance**
  - E.g. Possible formulas (36.6 or 32.4)
    - Free space: Loss (in dB) =  $36.6 + (20 \cdot \log_{10}(F)) + (20 \cdot \log_{10}(D))$
    - F (Mhz), D (miles)
- **Link budget issue: 6 dB rule**
  - Each 6 dB increase in EIRP (signal x 4) implies double Tx range (e.g. see table below: 2.4Ghz Path Loss vs distance)

100 meters	- 80.23 dB	-6 dB
200 meters	- 86.25 dB	
500 meters	- 94.21 dB	-6 dB
1000 meters	- 100.23 dB	
2000 meters	- 106.25 dB	-6 dB
5000 meters	- 114.21 dB	
10000 meters	- 120.23 dB	-6 dB

# Link Budget Calculation

- **“Link Budget” or “System Operating Margin”**
  - Excess of signal between transmitter and receiver
    - Calculated for outdoor point-to-point connections
  - Measured in dB (relative) or dBm or mW (absolute)
  - Calculation:
    - Receiver sensitivity RS (weakest detectable signal)
      - The lower the better: e.g. IEEE 802.11 card (see device manual), -95 dBm (1Mbps), -93 dBm (2 Mbps), -90 dBm (5.5 Mbps), -87 dBm (11 Mbps)
    - Link Budget: received power (in dBm) - RS (in dBm)
    - E.g. RS = -82 dBm, received power = -50 dBm
      - **Link budget = -50 - (-82) = +32 dBm**
    - This means the signal has margin of +32 dB before it becomes unviable
- **Fade margin: extra margin for link budget (to cope with multipath variation in indoor/outdoor scenarios): typical [+10..+20] dB**

# Link Budget Calculation: example

- Example: design of transmission system, needs amplifier?

